



**FIRE
RESISTANT
DOOR
HARDWARE
PROTECTION**

FIRE
RESISTANT
DOOR
HARDWARE
PROTECTION

FIRE
RESISTANT
DOOR
HARDWARE
PROTECTION





We've been designing and manufacturing high performance sealing systems for over 40 years.

And we're passionate about the products we make. Our dedicated R&D and testing facilities rigorously put our sealing systems through their paces – enabling us to enhance product form and function. We've built a strong reputation for design innovation; and for producing the highest quality sealing systems embracing acoustic, smoke, fire and thermal containment; as well as accessibility.

Respected throughout the industry for our technical expertise, we play an active role in helping to shape standards and best practice. We believe in providing excellent levels of customer service; and are at our best working in partnership with you.

Ironmongery is a vital part of a fire door. However, every time a fire door is cut to fit ironmongery, a weakness is created. This could mean three or four weak points in a door, where fire can take hold. Adding intumescent door hardware kits protects those weak points.

Our kits are made from intumescent sheet, which is wrapped around each piece of ironmongery such as hinges, locks and latches, door viewers and concealed closers, acting as an insulator. Tested with a range of ironmongery, our kits are supplied pre-cut to the exact dimensions, for quick and easy fitting.

**MADE IN
BRITAIN** 

 **LORIENT**

SEALING DOORS WORLDWIDE

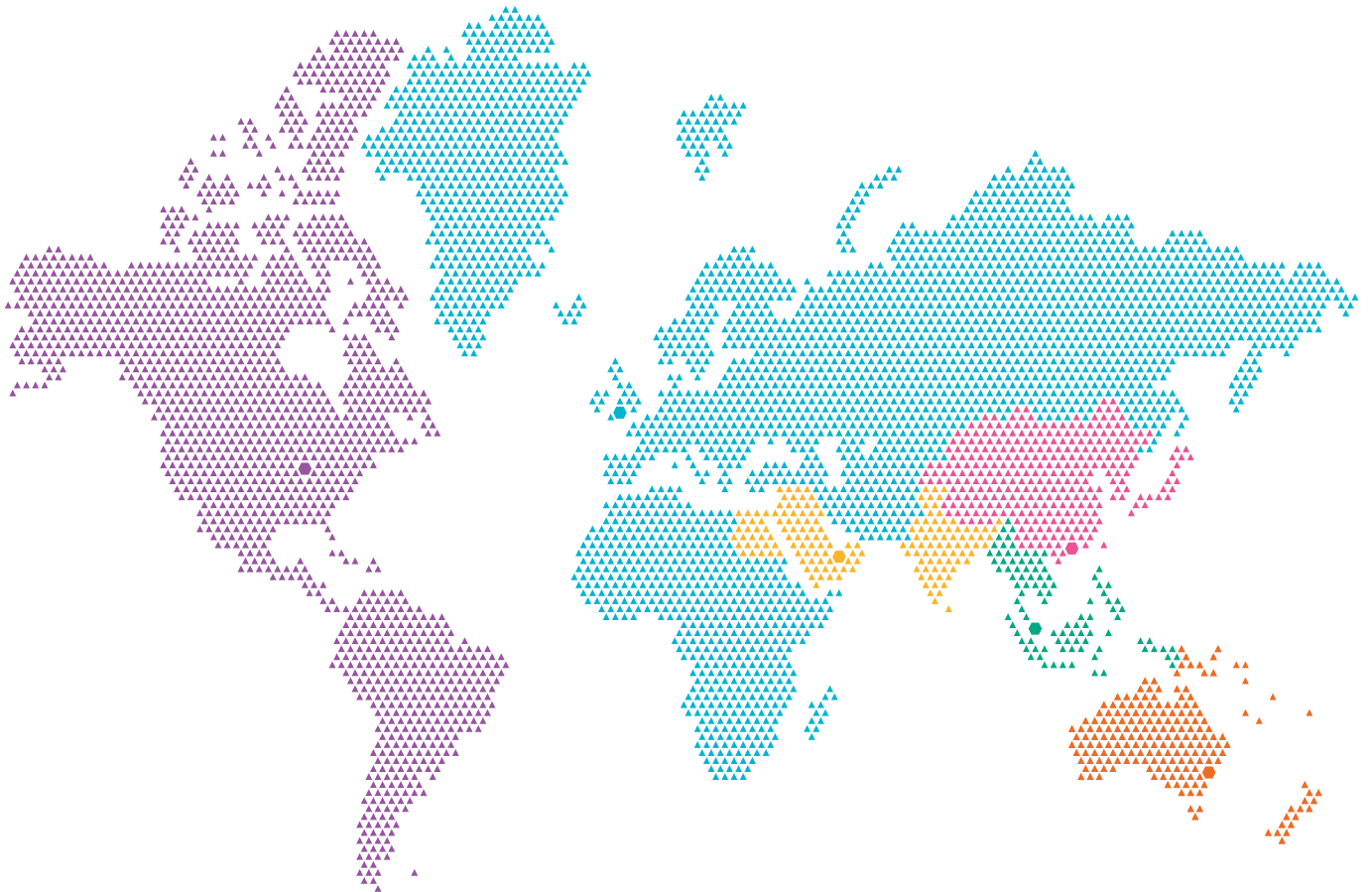

The UK is home to our head office, manufacturing operation and dedicated R&D testing facility. Our UK & Europe head office supports operations around the world, delivering the best solutions locally to our customers across four continents.

By keeping abreast of technical developments and changes to regulations and standards across the world, we deliver the highest levels of expertise and support.

 UNITED KINGDOM (HQ)

 AUSTRALIA

 SINGAPORE

 HONG KONG

 USA

 UAE





FIRE RESISTANT DOOR HARDWARE PROTECTION

CONTENTS

01	Introduction
02	Sealing Doors Worldwide
04	Regulations + Requirements
05	Product Selector
06 - 09	Letterplates
10	Door Edge Protector
11	Wide Angle Viewer
12 - 18	Hardware Protection Kits
19	Testing + Technical Services
20	Additional Information
22	CPD Seminars
24	Comprehensive Support
25	Sealing Systems

ICONS EXPLAINED

The following icons are used throughout this brochure to give clear and easy recognition of a particular seal's function or possible application. Use of the icons does not necessarily indicate that test evidence exists. Please check with the Lorient Technical team.

	Fire protection	30	FD30
	Smoke protection	60	FD60
	Acoustic protection	90	FD90
	Integrity	120	FD120
	Security protection		

PRODUCT ILLUSTRATIONS

All dimensions in this brochure are in millimetres.

REGULATIONS + REQUIREMENTS

On average 316 people are killed and 8,750 are injured* in fires each year in the UK alone. Many of the casualties are attributable to inhaling the toxic gases of combustion from a remote fire.

Fire and smoke also cause extensive damage to building fabric and contents. £2.52 billion* per annum is the estimated total of fire-related losses. The majority of these deaths, injuries and losses occur in buildings where fire and smoke protection measures have been inadequate.

Design Needs and Regulatory Requirements

When fire breaks out in a building the threat is twofold. Firstly, there is the fire itself and the hot smoke generated in the immediate vicinity. Secondly, there is cold smoke which will spread rapidly through the building, threatening people and property some distance from the fire.

The Building Regulations take both these threats into account, and supporting documents give criteria for how they can be managed. Details can be found in Approved Document B (England), Approved Document B (Wales), Technical Booklet E (N Ireland), and Technical Handbook Section 2 (Scotland).

The Regulations require large buildings to be divided into smaller fire and smoke resistant 'compartments', to reduce the risk of damage to the building as a whole and also to save lives in the case of a fire. Building a fire resistant wall or floor to make a compartment is relatively simple. However, building design becomes much more complex when the compartments need to be linked in some way – essential to make the building usable. Every time an aperture is cut into one of the compartment boundaries (for example, to install a door in a fire resistant wall, or to pass ductwork through a wall or ceiling) the aperture must be filled with something that will preserve the fire and smoke integrity of the compartment.

* Source: Communities and Local Government Website 2020 (Great Britain 2018/19).

That's the role of Lorient's products – to work with the surrounding elements of the building to ensure the fire and smoke resistant compartments are maintained. Our fire and smoke seals can be fitted into fire rated doors; our glazing products can be fitted into doors, screens or fire rated partitions; our air transfer grilles can be installed into doors, walls and ducts.

Fire and smoke protection products must be tested to prove their performance – and indeed, separate tests are required for fire and smoke. Our products are all extensively tested, and our test reports are freely available on request. Just call our Technical Services team on 01626 834252.

Fire Resistant Door Hardware

Fire rated doors often need additional items of hardware installed to make them work – hinges, locks, door closers, letterplates, security viewers – as well as products to protect them from damage. This brochure shows our products that can safely be installed into fire rated doors, without compromising the fire and smoke integrity of the doorset. Featured products include:

- ▶ a range of door hardware items which offer security and protection against smoke and fire;
- ▶ universal intumescent protection kits available for concealed door closers and other ironmongery items;
- ▶ durable door leaf edge protectors with built-in acoustic, smoke and fire seals.

Relevant Standards

There are several British Standards which relate to the products and solutions featured in this brochure. They include:

- ▶ **BS 476-22:1987** Methods for determination of the fire resistance of non-loadbearing elements of construction;
- ▶ **BS 476-31.1:1983** Methods for measuring smoke penetration through doorset and shutter assemblies;
- ▶ **BS EN 1634-1:2014+A1:2018** Fire resistance and smoke control tests for door and shutter assemblies, openable windows and elements of building hardware. Fire resistance test for door and shutter assemblies and openable windows;
- ▶ **BS EN 1634-3:2004** Fire resistance and smoke control tests for door and shutter assemblies, openable windows and elements of building hardware. Smoke control test for door and shutter assemblies;
- ▶ **BS 9999:2017** Code of practice for fire safety in the design, management and use of buildings;
- ▶ **TS 008:2015** Enhanced Security and General Requirements for Letter Plate Assemblies and Slide Through Boxes;
- ▶ **PAS 24:2016** Enhanced security performance requirements for doorsets and windows in the UK. Doorsets and windows intended to offer a level of security suitable for dwellings and other buildings exposed to comparable risk.

PRODUCT SELECTOR

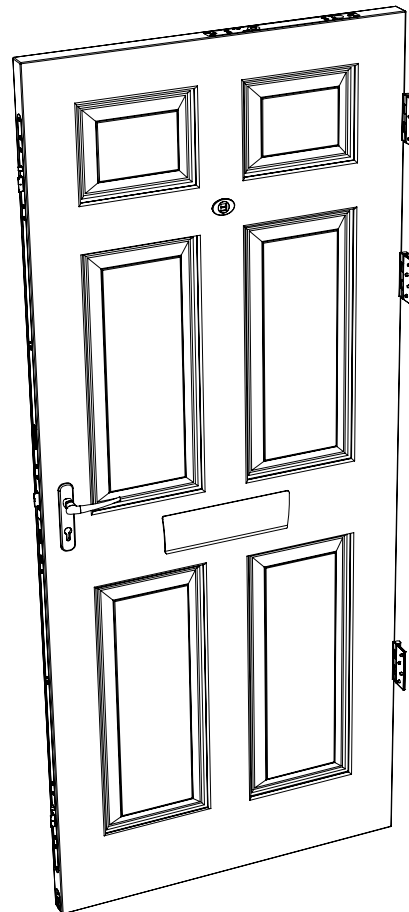
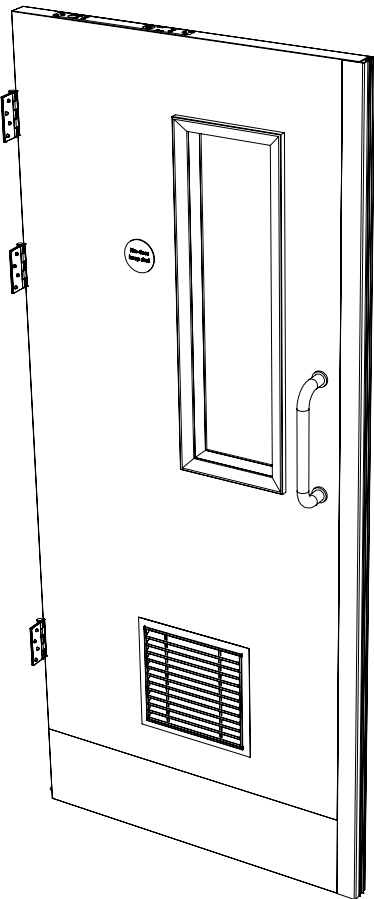

INTERNAL DOOR LEAF

- A Concealed Door Closer Protection Kits**
30, 60, 90 and 120 minutes fire protection (see page 17)
- B Door Edge Protector**
30 and 60 minutes fire and smoke protection (see page 12)
- C Hinge Protection Kits**
30, 60, 90 and 120 minutes fire protection (see page 15)
- D Glazing Seals**
We offer a range of glazing systems to cover doors, screens and partitions. Visit our website for more information: lorientuk.com
- E Air Transfer Grilles**
We offer a range of intumescent air transfer grilles for doors, walls, ducts, floors and ceilings. Visit our website for more information: lorientuk.com
- F Drop Seal Protection Kits**
30 and 60 minutes fire protection (see page 18)

FLAT FRONT ENTRANCE DOOR

- C Hinge Protection Kits**
30, 60, 90 and 120 minutes fire protection (see page 15)
- F Drop Seal Protection Kits**
30 and 60 minutes fire protection (see page 18)
- G Lock and Latch Protection Kits**
30, 60, 90 and 120 minutes fire protection (see page 16)
- H Letterplates**
30 and 60 minutes fire and smoke protection plus security option (see pages 9 - 11)
- I Wide Angle Viewer**
30 minutes fire protection (see page 13)

DOOR HARDWARE

This section shows a range of letterplates, door viewers and door edge protectors that can safely be installed into fire rated doors, without compromising the fire and smoke integrity of the doorset.



RJ008 LETTERPLATE

Designed to meet the exacting security standards of TS008:2015, the RJ008 letterplate is tested to withstand a series of physical tests based on the common methods of burglary. Providing up to 60 minutes fire resistance, this high performance letterplate is available in a number of stylish finishes.



Key benefits

- ▶ Tested to TS008:2015
- ▶ No visible fixings
- ▶ Anti-vandal® feature
- ▶ 37° opening to protect against 'key fishing'
- ▶ Quick and easy to install
- ▶ Can withstand thousands of openings
- ▶ Smooth working mechanism.



▲ RJ008 Letterplate

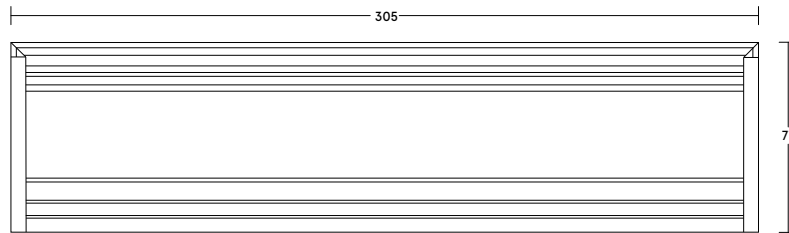
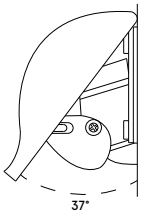

SYSTEM SPECIFICATIONS

Test evidence

- ▶ Fire: BS 476-22:1987 in an FD30.
- ▶ Fire: BS 476-22:1987 in an FD60.
- ▶ Security: PAS 24:2016.
- ▶ Classified to TS008:2015.
- ▶ Durability: 15,000 cycles.

Performance

- ▶ Can provide 30 and 60 minutes fire resistance.

Material

- ▶ Aluminium outer casing with an intumescent lining.

Internal frame sizes

- ▶ 300mm x 115mm.
- ▶ Projection: 35mm.

External frame sizes

- ▶ 305mm x 77mm.
- ▶ Distance between screw holes: 277mm.
- ▶ Mail aperture: 53mm x 260mm.

Door thickness

- ▶ 44mm timber door.
- ▶ 54mm timber door.

Finishes

- ▶ Black, white, polished silver, gold and silver anodised aluminium.

Accreditation

- ▶ BSI certified for PAS 24:2016.



KM670828



Official Police Security Initiative

LETTERPLATES



FIREMASTER FIRE + SMOKE RESISTANT LETTERPLATE

32dB

The Firemaster letterplate provides in excess of 30 minutes fire resistance and protection against cold smoke in line with BS 9999. It features a telescopic intumescent liner, making it suitable for a range of door thicknesses. A robust aluminium construction and nylon brush seals prevent vision through the letterplate, whilst also providing draught proofing.



LETTERPLATES

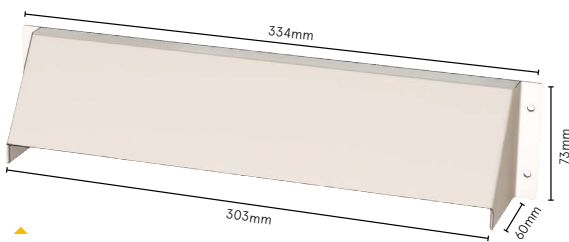

Security cowl
RJ 290X063C

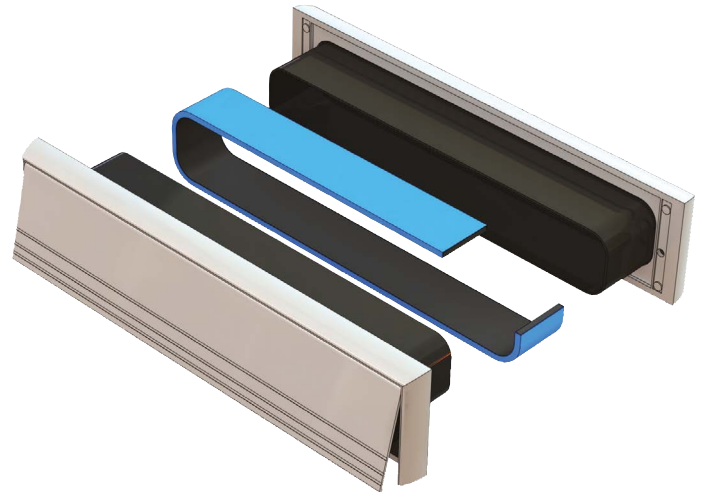

Firemaster fire + smoke resistant letterplate
RJS 29063

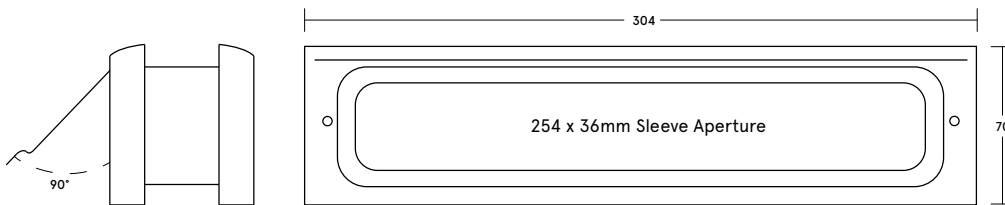

SYSTEM SPECIFICATIONS

Test evidence

- ▶ Fire: BS 476-20/22:1987.
- ▶ Smoke: BS 476-31.1:1983.
- ▶ Acoustic: BS EN ISO 717-1:2013 (up to Rw 32dB).
- ▶ Durability: 15,000 cycles.

Performance

- ▶ Can provide 30 minutes fire resistance.
- ▶ Provides protection against cold smoke in line with the requirements of BS 9999:2017 and Approved Document B.

Overall Size

- ▶ 304mm x 70mm.

Door thickness

- ▶ 40mm min.
- ▶ 70mm max.

Door aperture size

- ▶ 285mm x 55mm.

Seal material

- ▶ Graphite intumescent liner.

Finishes

- ▶ Silver anodised, polished silver or polished gold aluminium.

Use with

- ▶ A security cowl is available to prevent vision through the letterplate when open, and to inhibit manipulation of locks/bolts, tampering and attack from outside.

Accreditation

HIGH PERFORMANCE LETTERPLATE

The high performance letterplate provides in excess of 60 minutes fire resistance and protection against cold smoke in line with BS 9999. It is internally sealed so that the unit will not compromise the smoke integrity of the door whilst also providing draught proofing. Available with a range of security devices.

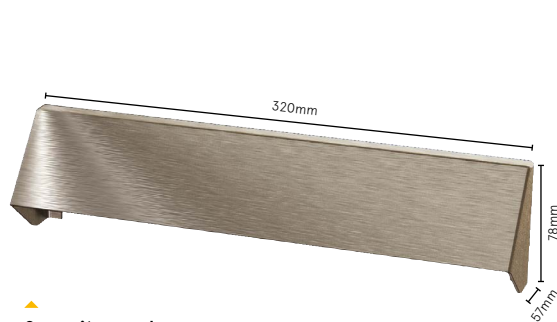

Security cowl
LP10



High performance fire,
smoke + security
letterplate

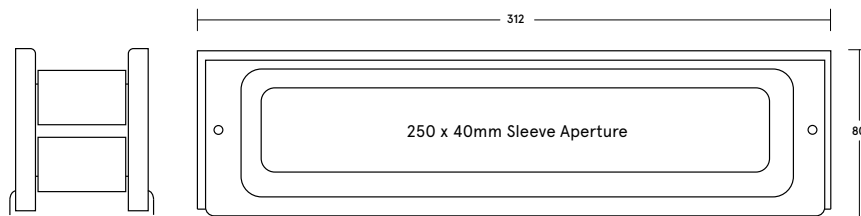

SYSTEM SPECIFICATIONS

Test evidence

- ▶ Fire: BS 476-22:1987.
- ▶ Fire: BS 476-31-1:1983.
- ▶ Durability: 15,000 cycles.

Performance

- ▶ Can provide 30 and 60 minutes fire resistance.
- ▶ Can provide protection against cold smoke in line with the requirements of BS 9999:2017 and Approved Document B when specified as part of a smoke controlled unit.

Size

- ▶ 312mm x 80mm.

Door Aperture Size

- ▶ 270mm x 60mm.

Door thickness

- ▶ 42mm - 47mm:
RJ 8042F + RJ 8042S.
- ▶ 47mm - 52mm:
RJ 8047F + RJ 8047S.
- ▶ 52mm - 57mm:
RJ 8052F + RJ 8052S.

Seal material

- ▶ Graphite intumescent liner.

Can be used with

- ▶ Security cowl: LP10.
- ▶ Internal security latch: LP11.
- ▶ Lockable post-box: LP12.

Finishes

- ▶ FD30: Silver or gold anodised as standard. Other powder coated finishes (non-standard charge and lead times apply).
- ▶ FD60: Brushed, satin or polished stainless steel as standard. Other finishes are available to special order, please contact us for more information (non-standard charge and lead times apply).
- ▶ **Note:** Powder coated steel is for internal use only.

Accreditation



DOOR EDGE PROTECTOR

Some doors suffer severe damage to the leading edge due to heavy volumes of pedestrian and wheeled traffic.

Lorient's door edge protector incorporates the innovative DS seal. Together they offer superior combined protection against damage, fire, smoke, and sound.



DOOR EDGE PROTECTOR

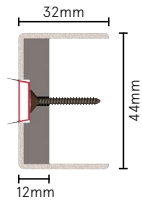

RJ 4432S

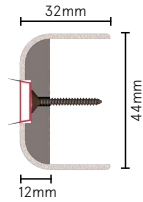

RJ 4432R

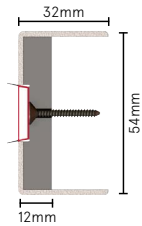

RJ 5432S

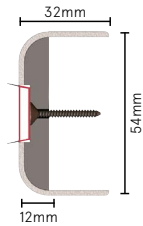

RJ 5432R

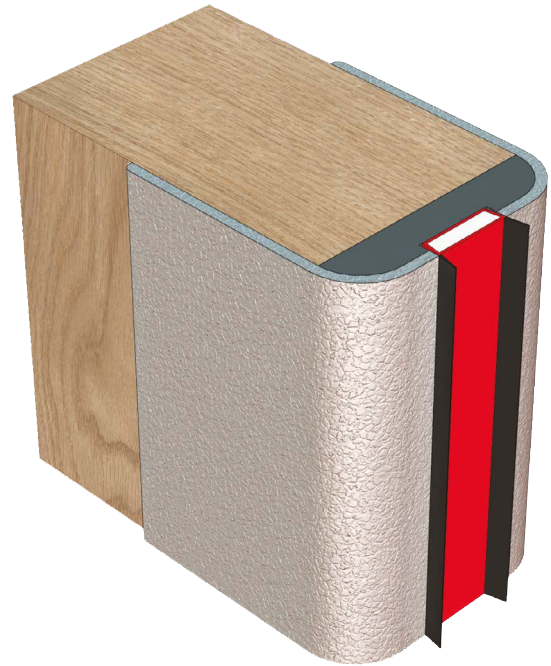

Edge protector shown with DS seal

SYSTEM SPECIFICATIONS

Test evidence

- ▶ Fire: BS 476-22:1987.
- ▶ Fire: BS 476-31.1:1983.
- ▶ Integrity: 68 minutes.

Performance

- ▶ Can provide up to 30 or 60 minutes fire resistance.
- ▶ Protects against fire, smoke and sound.
- ▶ Low frictional elastomeric fins of the DS seal enable ease of door operation – meeting the requirements of Approved Document M.

Location

- ▶ Door edge.

Standard lengths

- ▶ 2.1m as standard.
- ▶ Other lengths are available to special order.

Standard leg lengths

- ▶ 32mm or 50mm.

Door thickness

- ▶ FD30: 44mm.
- ▶ FD60: 54mm.

Edges

- ▶ Radius or square.
- ▶ Double swing types also available (40mm leg length only).

Seal material

- ▶ Sodium silicate.

Finishes

- ▶ Hessian (textured) or Falmouth (smoother with light stippling).
- ▶ Available in a range of NCS colours with varying light reflective values (LRV).

Use with

- ▶ Laminated softwood or hardwood, flaxboard or particleboard or solid homogeneous particleboard doors.
- ▶ Note: For pairs of doors, one door leaf should be fitted with a fire seal only edge protector and the other should be fitted with a DS seal edge protector. Brush type fire and smoke seals are also available. Matching items can be supplied, including push plates, kick plates and door panels.

WIDE ANGLE VIEWER

A one-way viewer which allows occupants to see and identify callers. The viewer is supplied with an integral intumescent liner. Tests prove that the viewer can be fitted to 30 minute fire resistant doors without compromising fire safety.

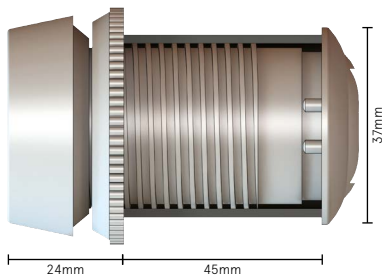

Wide angle viewer

WIDE ANGLE VIEWER

SYSTEM SPECIFICATIONS

Test evidence

- ▶ Fire: BS 476-22:1987.

Performance

- ▶ Can provide up to 30 minutes fire resistance when fitted to full size door assemblies and tested in accordance with BS 476-22:1987.
- ▶ A wide viewing angle of 160°.
- ▶ Allows callers to be seen and identified without opening the door.
- ▶ Projects an image of the caller onto an etched glass screen, which can be easily viewed from a convenient distance. It is not necessary to have the eye so close to the viewer that there is a risk of penetration from sharp objects.

Size

- ▶ 37mm x 69mm.

Door aperture size

- ▶ 42mm.

Door thickness

- ▶ 44mm.

Seal material

- ▶ Graphite intumescent liner.

Fixing

- ▶ Wrap the barrel of the door viewer with the intumescent sleeve supplied.

Finishes

- ▶ Black, gold, silver, bronze or white.

HARDWARE PROTECTION KITS

Our intumescent protection kits consist of a thin, high performance intumescent sheet, pre-cut and scored - ready for a quick and easy installation. We offer a range of kits designed for use with; hinges, locks and latches, drop seals, flush bolts and concealed door closers.



HINGE PROTECTION KITS

Lorient provides bespoke intumescent hinge kits, which provide fire resistance of 30, 60, 90 or 120 minutes when tested with full size door assemblies in accordance with BS 476-22:1987 and BS EN 1634-1:2014+A1:2018.

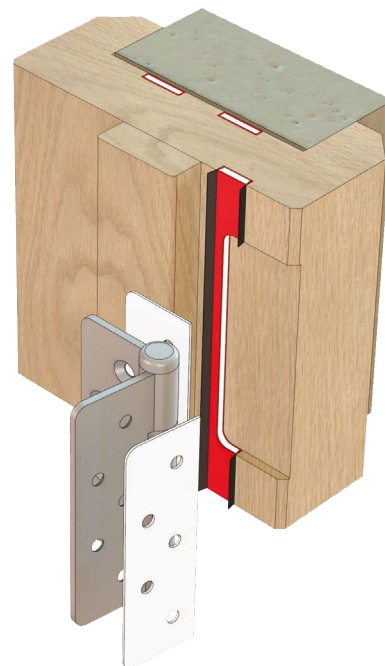
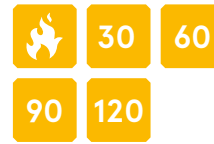

▲ Hinge protection kit

INTUMESCENT PROTECTION KITS

SYSTEM SPECIFICATIONS

Test evidence

- ▶ Fire: BS 476-22:1987
- ▶ Fire: BS EN 1634-1:2014+A1:2018.

Performance

- ▶ Can provide up to 30, 60, 90 or 120 minutes fire resistance.

Size

- ▶ Lorient can supply bespoke intumescent protection kits for commonly specified hinges.

Location

- ▶ Underneath each hinge leaf.

Seal material

- ▶ Mono Ammonium Phosphate (MAP) 1mm / 2mm.
- ▶ With or without self-adhesive backing.

Use with

- ▶ Recommended for use with CE Marked hinges tested in accordance with BS EN 1935.

Finishes

- ▶ Square or radius profile, with or without self-adhesive backing.

Fixing

- ▶ Place the intumescent pad underneath the hinge leaf.

Preparation

- ▶ Prepare the substrate for receiving intumescent hardware protection by ensuring it is clean from dust and oils. We recommend the use of non-solvent based wipes, wipe with a non-lint cloth to ensure surface is completely dry before application.
- ▶ Remove self-adhesive backing and dispose of in line with local regulations.
- ▶ Apply intumescent hardware protection, ensuring any cut outs and relief section are in alignment with hardware detail. Press firmly.



LOCK + LATCH PROTECTION KITS

Lorient provides bespoke lock kits, which enable family groups of mortise locks to be fitted in fire resistant door leaves.

These jackets provide fire resistance of 30, 60, 90 or 120 minutes when tested with full size door assemblies and tested in accordance with BS 476-22:1987 and BS EN 1634-1:2014+A1:2018.

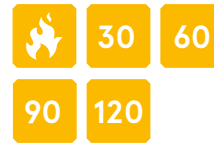

INTUMESCENT PROTECTION KITS



▲ Lock + latch protection kit

SYSTEM SPECIFICATIONS

Test evidence

- ▶ Fire: BS 476-22:1987
- ▶ Fire: BS EN 1634-1:2014+A1:2018.

Performance

- ▶ Can provide up to 30, 60, 90 or 120 minutes fire resistance.

Size

- ▶ Lorient can supply intumescent jackets to suit a range of locks and latches, please contact us for details.

Seal material

- ▶ Mono Ammonium Phosphate (MAP) 1mm / 2mm.
- ▶ With or without self-adhesive backing.

Fixing

- ▶ Wrap the intumescent jacket around the lock case, under the forend and around the strike if needed.

Use with

- ▶ UK lock cases.
- ▶ European lock cases.
- ▶ Multi-point locks.
- ▶ Electro-mechanical locks.

Preparation

- ▶ Prepare the substrate for receiving intumescent hardware protection by ensuring it is clean from dust and oils. We recommend the use of non-solvent based wipes, wipe with a non-lint cloth to ensure surface is completely dry before application.
- ▶ Remove self-adhesive backing and dispose of in line with local regulations.
- ▶ Apply intumescent hardware protection, ensuring any cut outs and relief section are in alignment with hardware detail. Press firmly.

CONCEALED DOOR CLOSER PROTECTION KITS

Lorient intumescent protection kits consist of thin, high performance intumescent sheets, pre-cut and scored so they can be easily fitted around concealed door closers.

The low pressure intumescent action ensures the door leaf is not split. Insulation against heat transfer is provided as soon as the intumescent material is activated.

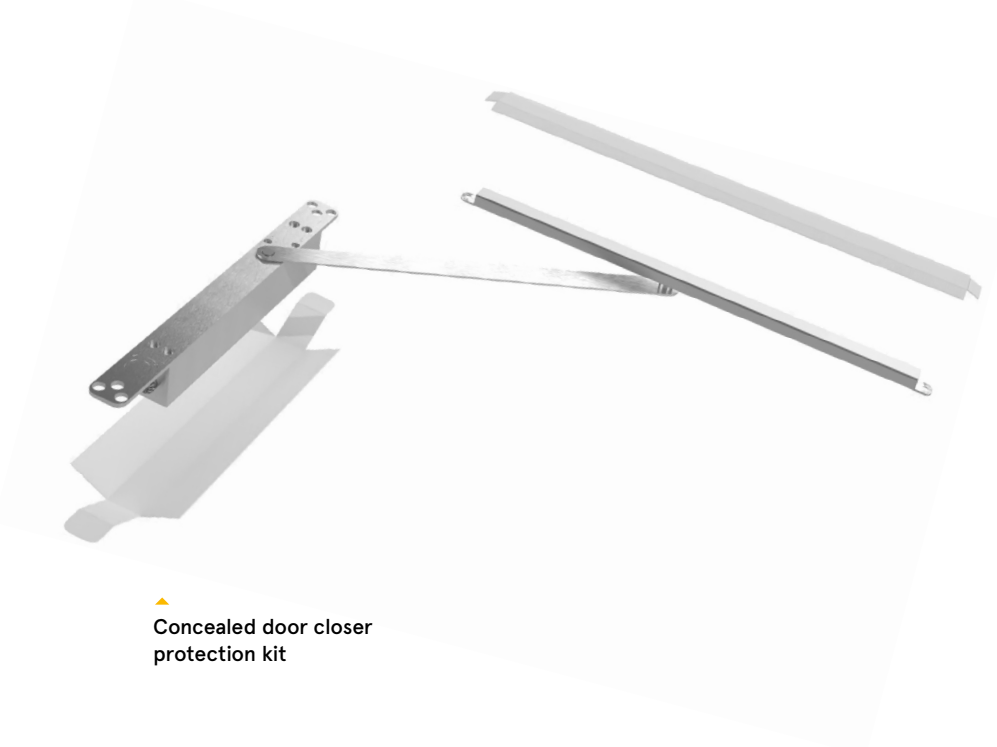
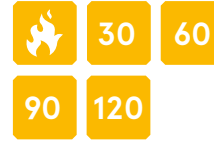

Concealed door closer protection kit

SYSTEM SPECIFICATIONS

Test evidence

- ▶ Fire: BS 476-22:1987
- ▶ Fire: BS EN 1634-1:2014+A1:2018.

Performance

- ▶ Can provide up to 30, 60, 90 or 120 minutes fire resistance.

Location

- ▶ Around the door closer within the door leaf and frame head.

Use with

- ▶ Bespoke intumescent kits can be made to suit a number of concealed door closers, please contact us for more information.

Seal material

- ▶ Mono Ammonium Phosphate (MAP) 1mm / 2mm.
- ▶ With or without self-adhesive backing.

Fixing

- ▶ Wrap one of the intumescent liners around the door closer for the door leaf.
- ▶ Wrap the second intumescent liner around the door closer head rail for the frame head.

Size

- ▶ Lorient can supply bespoke intumescent protection kits for commonly specified concealed door closers.

Preparation

- ▶ Prepare the substrate for receiving intumescent hardware protection by ensuring it is clean from dust and oils. We recommend the use of non-solvent based wipes, wipe with a non-lint cloth to ensure surface is completely dry before application.
- ▶ Remove self-adhesive backing and dispose of in line with local regulations.
- ▶ Apply intumescent hardware protection, ensuring any cut outs and relief section are in alignment with hardware detail. Press firmly.



DROP SEAL PROTECTION KITS

Lorient provides intumescent protection kits which enable the LAS8001 si drop seal to be fitted in fire resistant door leaves.



These jackets provide fire resistance of 30 minutes or 60 minutes when tested with full size door assemblies and tested in accordance with BS 476-22:1987 and BS EN 1634-1:2014+A1:2018.

INTUMESCENT PROTECTION KITS



Drop seal protection kit

SYSTEM SPECIFICATIONS

Test evidence

- ▶ Fire: BS 476-22:1987.
- ▶ Fire: BS EN 1634-1:2014+A1:2018.

Performance

- ▶ Can provide up to 30 or 60 minutes fire resistance.

Size

- ▶ Lorient can supply intumescent kits to suit standard lengths of LAS8001 si drop seals.

Seal material

- ▶ Mono Ammonium Phosphate (MAP) 1mm / 2mm.
- ▶ With self-adhesive backing.

Use with

- ▶ LAS8001 si drop seal.

Fixing

- ▶ Affix the intumescent kit onto the top and two sides of the drop seal.

Preparation

- ▶ Prepare the substrate for receiving intumescent hardware protection by ensuring it is clean from dust and oils. We recommend the use of non-solvent based wipes, wipe with a non-lint cloth to ensure surface is completely dry before application.
- ▶ Remove self-adhesive backing and dispose of in line with local regulations.
- ▶ Apply intumescent hardware protection, ensuring any cut outs and relief section are in alignment with hardware detail. Press firmly.

FLUSH BOLT PROTECTION KITS

Lorient provides intumescent kits which enable flush bolts to be fitted in fire resistant door leaves.

These kits provide fire resistance of 30 minutes or 60 minutes when tested with full size door assemblies and tested in accordance with BS 476-22:1987 and BS EN 1634-1:2014+A1:2018.



30

60



INTUMESCENT PROTECTION KITS

Flush bolt protection kit ▶
shown with LAS9010, which
interacts with the LAS8001 si

SYSTEM SPECIFICATIONS

Test evidence

- ▶ Fire: BS 476-22:1987.
- ▶ Fire: BS EN 1634-1:2014+A1:2018.

Performance

- ▶ Can provide up to 30 or 60 minutes fire resistance.

Location

- ▶ Back of the groove for the flush bolt.
- ▶ Under the keep.

Use with

- ▶ These kits can be used with the LAS9010 flush bolt + LAS8001 si drop seal.
- ▶ Bespoke intumescent kits can be made for a number of flush bolts, please contact us for more information.

Seal material

- ▶ Mono Ammonium Phosphate (MAP) 1mm / 2mm.
- ▶ With self-adhesive backing.

Fixing

- ▶ Affix self-adhesive intumescent cladding kit to the back of the groove or to the body of the flush bolt (kit dependant).
- ▶ Affix self-adhesive intumescent kit under the keep.

Size

- ▶ Lorient can supply bespoke intumescent protection kits for commonly specified flush bolts.

Preparation

- ▶ Prepare the substrate for receiving intumescent hardware protection by ensuring it is clean from dust and oils. We recommend the use of non-solvent based wipes, wipe with a non-lint cloth to ensure surface is completely dry before application.
- ▶ Remove self-adhesive backing and dispose of in line with local regulations.
- ▶ Apply intumescent hardware protection, ensuring any cut outs and relief section are in alignment with hardware detail. Press firmly.



BESPOKE INTUMESCENT PROTECTION KITS

Lorient is able to design and manufacture bespoke intumescent kits to suit all door hardware requirements.

Utilising in-house expertise, bespoke products can be developed and customised for you.

Our range of intumescent materials can be used to provide fire protection for any hardware which requires protection, including:

- ▶ Cable ways
- ▶ Through bolts for handles, locks and closers.



▶ Cable way protection



▶ Lock protection kit

INTUMESCENT PROTECTION KITS

SYSTEM SPECIFICATIONS

Test evidence

- ▶ Application specific - we can work with you to meet the required standards of:
- ▶ Fire: BS 476-22:1987.
- ▶ Fire: BS EN 1634-1:2014+A1:2018.

Performance

- ▶ Can provide up to 30 or 60 minutes fire resistance.

Use with

- ▶ Our bespoke intumescent kits can be used across any ironmongery which requires enclosing, please contact us for further information.

Typical Seal material

- ▶ Foam graphite.
- ▶ Mono Ammonium Phosphate.
- ▶ Other materials relevant to application.

TESTING + TECHNICAL SERVICES

We've built our reputation on the quality and dependability of our products, and our investment in R&D has played a pivotal role in keeping our products at the forefront of our industry. Our dedicated Testing and Technical Services division has established itself as an important facility for manufacturers and designers of doors, windows, glazing systems and hardware, to name just a few.

TESTING SERVICES

Whether you're investigating new materials, or developing new or existing products, right through to durability testing and benchmarking performance – our team of experts will support you throughout the process. We are able to offer:

- ▶ Full scale acoustic testing. Lorient's acoustic transmission suite is designed to meet the requirements of BS EN ISO 10140-2:2010
- ▶ Fire testing (indicative)
- ▶ Smoke leakage
- ▶ Air leakage
- ▶ ATG commissioning and maintenance for fire & smoke resisting air transfer grilles
- ▶ Mechanical cycling
- ▶ Environmental chamber analysis
- ▶ Attendance at external fire tests
- ▶ Consultancy services.

▲
Lorient Indicative Furnace

ADDITIONAL INFORMATION

TECHNICAL REFERENCES

Lorient is quality assured under the disciplines of BS EN ISO 9001:2015.

Accreditation to this standard is an assurance that we conduct our business to the complete satisfaction of our customers with regard to design solutions, manufacturing consistency and management procedures.

As a result, this internationally recognised standard for quality management generates customer confidence. Regular audits of our company procedures are undertaken by qualified BSI staff to ensure ongoing compliance with all aspects of the standard.



BS EN ISO 9001:2015 Certificate No. Q6104

Lorient has attained the BS EN ISO 14001:2015 accreditation for environmental management, making us the first seal manufacturer to have achieved this important award. This internationally recognised standard shows that we have demonstrated our commitment to responsible environmental behaviour, including prevention of pollution, control and reduction of waste, and ongoing monitoring and improvement of our environmental performance. Achieving ISO 14001 is just one part of our ongoing commitment to operate in a sustainable way.



BS EN ISO 14001:2015 Certificate No. EMS 541906

FITTING INSTRUCTIONS

Comprehensive fitting instructions are included with each consignment; and are also available to download from our website www.lorientuk.com

MAINTENANCE

Periodic inspection and cleaning is recommended for all products. Worn or damaged seals should be replaced immediately.

Please Note: Recommendations as to methods, use of materials and construction details are based on the experience and knowledge of Lorient and are given in good faith as a general guide and a service to designers, contractors and manufacturers.

INTELLECTUAL PROPERTY

© 2022 Lorient Polyproducts Ltd – this brochure is protected by copyright and neither the drawings nor the text may be reproduced or transmitted in any form without prior consent from Lorient. Lorient products described in this brochure are protected by patents and design registrations in Great Britain and other countries.

We are committed to continually enhancing and improving our product range. We reserve the right to change product specifications from time to time without prior notice. E&OE.

April 2022.

MADE IN BRITAIN

We are proud to have been granted the prestigious Made in Britain marque for our products, designed and manufactured at our main facility in South West of the UK.



TRADE ASSOCIATIONS

Lorient is a member and active contributor to the following:



ACCREDITATIONS

BBA

BBA approvals provide independent assurance for the designer, specifier and end-user as to the 'fitness for purpose' of building products.



CERTIFIRE

Operated by Exova Warringtonfire, CERTIFIRE is an accredited independent product conformity scheme that requires products to meet the requirements of the tests, to add minimal resistance to opening and closing forces, to prove long term performance under a variety of service conditions, and to be permanently marked for easy identification.



IFC

IFC Certification Ltd is a UKAS approved and internationally recognised provider of third party Certification services – designed to give confidence to specifiers, users, occupiers, owners and enforcement bodies that products have been thoroughly and independently evaluated and will continue to be manufactured to the same specification as originally tested.



UL

UL is a global independent safety science company that tests a diverse range of products; representative samples of a product must be tested and meet UL's stringent requirements to carry the marque. These requirements are based primarily on UL's published and nationally recognised Standards for Safety. Businesses, consumers and regulatory authorities around the world recognise the trusted rigour and technical excellence of UL certifications. Lorient is proud to have achieved the UL Mark on many of its products. These are detailed on individual pages.



CPDs

We offer three fully-accredited CPD seminars. Impartially presented by knowledgeable speakers, the seminars are structured to be technically informative, and provide practical advice.

Performance Door Design: The Basics of Sound Reduction

Effective acoustic containment helps to improve the quality of the built environment, preserving privacy as well as excluding unwanted noise. With changing regulations, it's essential to be informed of the relevant requirements and the implications for door assemblies.

Our acoustic CPD seminar covers:

- ▶ the nature of sound, examining airborne transmission of sound;
- ▶ regulatory requirements and British Standards that relate to acoustic performance;
- ▶ test procedures and interpretation of test reports;
- ▶ effective design of door assemblies for acoustic performance, including door construction and the influence of sealing systems;
- ▶ design conflicts between acoustic performance, durability and ease of operation of the door;
- ▶ independent accreditation.

The Role and Performance of Fire and Smoke-Resisting Door Assemblies

The importance of fire and smoke resisting door assemblies is illustrated by the 311 fire related fatalities and 7,772 casualties in fires (Great Britain 2020/21). Apart from the human toll, property losses each year approach £2.52 billion.

Our fire and smoke containment CPD seminar covers:

- ▶ hard facts concerning deaths, injuries and property damage caused by fire and smoke;
- ▶ regulatory requirements for fire and smoke resisting door assemblies;
- ▶ the nature and behaviour of smoke;
- ▶ effective design of door assemblies for smoke containment, including the threshold gap;
- ▶ design conflicts between fire containment, smoke containment, durability and ease of operation of the door;
- ▶ independent accreditation.

The Regulatory Reform (Fire Safety) Order 2005 and its implications for fire doors

The RRO consolidated 70 pieces of legislation; shifted responsibility for fire safety management; abolished the Fire Safety Certificate; established the Fire Risk Assessment and created major change in legal liability.

Our RRO CPD seminar covers:

- ▶ an overview of the RRO;
- ▶ product solutions;
- ▶ the dangers of fire and smoke;
- ▶ the importance of fire doors – including installation and maintenance.

Our CPD materials have been independently verified and certified by the RIBA as CPD approved. A certificate for 1 hour's CPD will be provided, which contributes to Continuing Professional Development requirements.

If you are interested in booking a seminar, please contact our Marketing department or email cpd@lorientuk.com



AIR TRANSFER GRILLE CPD WEBINAR

We're delighted to offer a CPD entitled:
The Specification + Design of Air Transfer Grilles / Dampers.

This is a fantastic addition to our growing collection of CPD seminars and explores:

- ▶ the latest test standards and building regulations;
- ▶ the major difference between intumescent air transfer grilles and dampers;
- ▶ the importance of correct specification, installation and maintenance;
- ▶ plus it offers practical solutions to fire and smoke containment over a range of applications.

All of our CPD seminars are available to view virtually, please visit www.lorientuk.com or email cpd@lorientuk.com for more information.

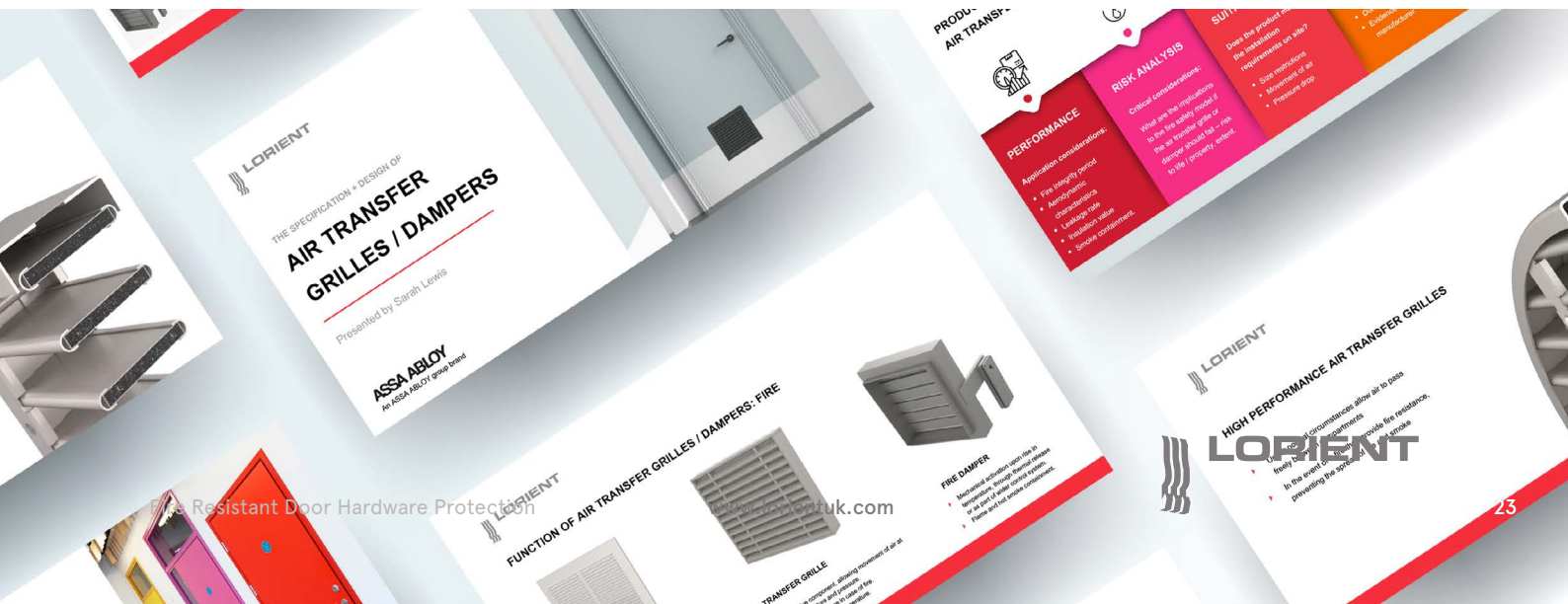

COMPREHENSIVE SUPPORT

As a company we have over 40 years' experience, so our experts are well equipped to listen, help and advise you on your sealing system requirements.

Technical Services

We're happy to provide specialist advice on acoustic, smoke and fire protection for refurbishment and new build projects. If you need assistance, you can call our Technical Services team.

Alternatively, we can arrange a site visit to get a clearer idea of your needs and how we can help you. We also provide copies of test reports and samples where needed; and can give guidance on how best to meet Building Regulations and Standards.

Web Support

Our website features a comprehensive range of supporting documents covering the entire range of products, including installation guides and CAD drawings. All of our brochures and products sheets are also available for download, together with copies of certification and specification texts.

Online Acoustic Search tool

Our Acoustic Search tool on our website gives you quick and easy access to a wide range of tested acoustic sealing systems on a variety of popular door constructions & configurations.

www.lorientuk.com/acousticsearch

The tool allows users to select a specific decibel rating; along with door configuration, fire door rating, doorset type etc to filter the results. The 'Acoustic Search' tool is updated frequently with Lorient's ever-expanding portfolio of test evidence. If you're looking for high performance or specialist applications – please contact us on **+44 (0) 1626 834252**, there may be some additional configurations we haven't yet published.

Customisation

If you have a particular requirement which isn't covered by the applications in this brochure, we may be able to supply an existing non-standard item, or even develop a customised solution for you. Utilising in-house expertise, bespoke products are created to your requirements; from a functional or aesthetic perspective, or both.

Lorient's dedicated Technical Services team supports and works as part of your design team, offering informed product advice and guidance on regulatory requirements and standards.



Call our Technical Services team
+44 (0) 1626 834252

www.lorientuk.com

SEALING SOLUTIONS

Detailed information about our products can be found in the following brochures:

Acoustic Sealing Systems for Door Assemblies

A comprehensive series of acoustic sealing systems for various types of door construction.

Acoustic, Smoke and Fire Seals for Door Assemblies

Our core range of high performance acoustic, smoke and fire seals.

AURA® Architectural Seals

A discerning selection of drop seals, perimeter seals, door bottom seals, threshold plates and ramps - all with strong design accents.

Lorient Architectural Seals

A variety of complementary door sealing systems including perimeter seals, drop seals, threshold plates, door bottom seals etc.

Fire Resistant Door Hardware Protection

Letterplates, door viewers, door edge protectors and intumescent kits that can safely be installed into fire rated doors without compromising the fire/smoke performance.

Fire Resistant Glazing Systems

Fire resistant glazing systems for doors, screens and partitions.

Fire and Smoke Resistant Air Transfer Grilles

A comprehensive range of intumescent air transfer grilles for doors, walls, ducts, floors and ceilings.

Copies of these brochures are available by calling **01626 834252** or download from our website **www.lorientuk.com**



UK / EUROPE

T: +44 (0) 1626 834252
F: +44 (0) 1626 833166
E: sales@lorientuk.com

AUSTRALIA

T: +61 (0) 3 8574 3888
E: customerservice.au@assaabloy.com

HONG KONG

T: +852 2260 0888
F: +852 2686 8682
E: sales@lorienthk.com

SINGAPORE

T: +65 6270 1279
E: sales@lorient.com.sg

UAE

T: +9714 883 7206
F: +9714 883 7207
E: sales@lorientgulf.ae

USA

T: +1 859 252 7441
F: +1 859 381 1241
E: info@lorientna.com

For further information about
Lorient products please visit:
www.lorientgroup.com

@LorientUK

/company/lorient

@lorientuk

/LorientPolyproducts