



**ACOUSTIC,
SMOKE + FIRE
SEALS FOR DOOR
ASSEMBLIES**

ACOUSTIC
SMOKE + FIRE
SEALS FOR DOOR
ASSEMBLIES
ACOUSTIC
SMOKE + FIRE
SEALS FOR DOOR
ASSEMBLIES



We've been designing and manufacturing high performance sealing systems for over 40 years.

And we're passionate about the products we make. Our dedicated R&D and testing facilities rigorously put our sealing systems through their paces – enabling us to enhance product form and function. We've built a strong reputation for design innovation; and for producing the highest quality sealing systems embracing acoustic, smoke, fire and thermal containment; as well as accessibility.

Respected throughout the industry for our technical expertise, we play an active role in helping to shape standards and best practice. We believe in providing excellent levels of customer service; and are at our best working in partnership with you.

**MADE IN
BRITAIN** 

SEALING DOORS WORLDWIDE

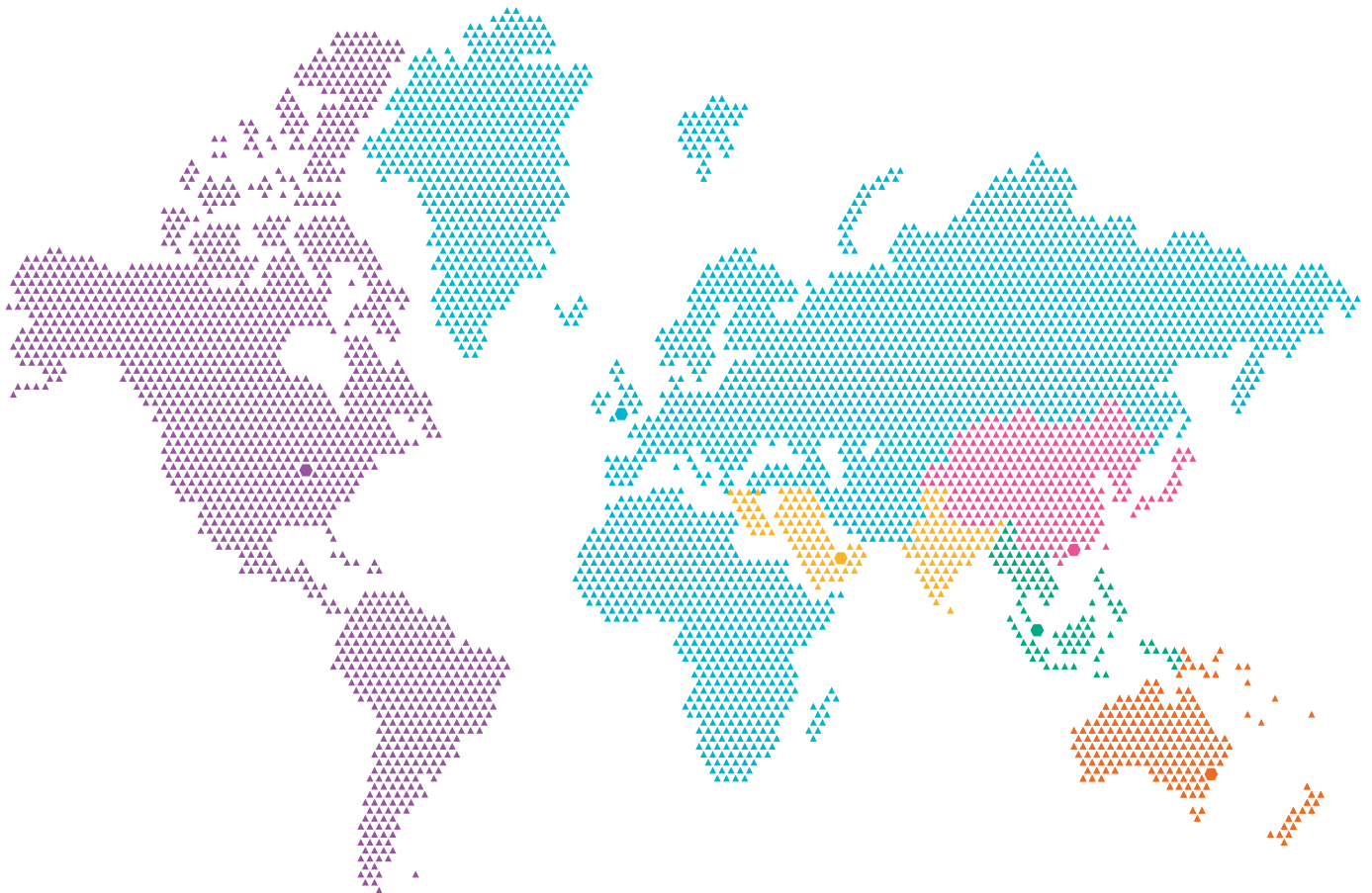

The UK is home to our head office, manufacturing operation and dedicated R&D testing facility. Our UK & Europe head office supports operations around the world, delivering the best solutions locally to our customers across four continents.

By keeping abreast of technical developments and changes to regulations and standards across the world, we deliver the highest levels of expertise and support.

 UNITED KINGDOM (HQ)

 AUSTRALIA

 SINGAPORE

 HONG KONG

 USA

 UAE

ACOUSTIC, SMOKE + FIRE SEALS

CONTENTS

ICONS EXPLAINED

The following icons are used throughout this brochure to give clear and easy recognition of a particular seal's function or possible application. Use of the icons does not necessarily indicate that test evidence exists. Please check with the Lorient Technical team.



Fire protection



Smoke protection



Acoustic protection



Light protection



Draught protection



Thermal containment properties



Wheelchair friendly



www.lorientuk.com/acousticsearch
Our Acoustic Search tool provides quick and easy access to a wide range of tested acoustic sealing systems on a variety of popular door constructions and configurations.

PRODUCT ILLUSTRATIONS

All dimensions in this brochure are in millimetres.

LIFE THREATENING FORCES

On average 311 people are killed and 7,772 are injured* in fires each year in the UK alone. Many of the casualties are attributable to breathing the toxic products of combustion from a remote fire.



England 2021/22. Source: Home Office 2023.

Design Needs and Regulatory Requirements

When fire breaks out in a building the threat is twofold. Firstly, there is the fire itself and the hot smoke generated in the immediate vicinity. Secondly, there is cold smoke which will spread rapidly through the building, threatening people and property some distance from the fire. The Building Regulations take both these threats into account, and supporting documents give criteria for how they can be managed. Details can be found in Approved Document B (England & Wales), Technical Booklet E (N Ireland), and Technical Handbook Section 2 (Scotland).

The Regulations require large buildings to be divided into smaller fire and smoke resistant 'compartments', to reduce the risk of damage to the

building as a whole and also to save lives in the case of a fire. Building a fire resistant wall or floor to make a compartment is relatively simple. However, building design becomes much more complex when the compartments need to be linked in some way – essential to make the building usable. Every time an aperture is cut into one of the compartment boundaries (for example, to install a door in a fire resistant wall, or to pass ductwork through a wall or ceiling) the aperture must be filled with something that will preserve the fire and smoke integrity of the compartment.

That's the role of Lorient's products – to work with the surrounding elements of the building to preserve the integrity of the fire and smoke resistant compartments.

Our fire and smoke seals can be fitted into fire rated doors; our glazing products can be fitted into doors, screens or fire rated partitions; our air transfer grilles can be installed into doors, walls and ducts.

Fire and smoke protection products must be tested to prove their performance, and indeed, separate tests are required for fire and smoke. Our products are all extensively tested, and our test reports are freely available on request.



Call our Technical Services team

+44 (0) 1626 834252

www.lorientuk.com

HIGH PERFORMANCE SEALING SYSTEMS

Today's architectural door assembly is heavily dependent on sealing systems for its performance; be that fire, smoke, acoustic or thermal containment. In choosing the right sealing solution, it's essential to make sure it's compatible with the door assembly.



INTUMESCENT SEALING

Our intumescent fire seals and combined acoustic, smoke and fire seals consist of intumescent material encased in rigid PVC which, for the combined seals also provides the carrier for an acoustic and smoke seal.

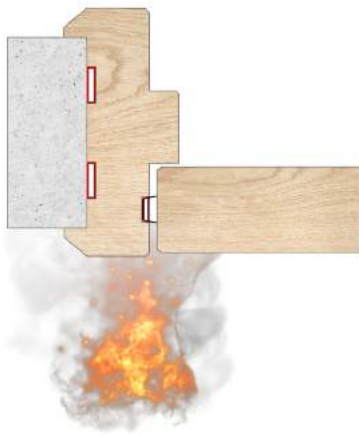

Fin type seals prevent the passage of cold smoke

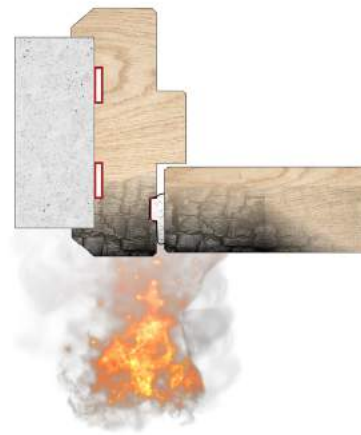

Combined seals provide an effective barrier to the passage of fire and hot smoke

The intumescent material used in the mainstream range of our seals is sodium silicate based. This material has been chosen for several reasons:

- ▶ it has been proven in many hundreds of fire tests, world-wide;
- ▶ it's renowned for its comprehensive spread of performance characteristics;
- ▶ it has demonstrated outstanding consistency, reliability and durability.

Cold smoke sealing

We offer a range of smoke seal profiles, which incorporate either a polypropylene brush pile; or elastomeric fins which offer durable, low-friction performance for ease of door operation, and enhanced smoke and acoustic protection.

Our range of cold smoke seals include products which can be used to upgrade existing fire rated doors to provide protection against cold smoke and sound. Specially designed to overcome the problems described above, they can be retrofitted with minimal disruption to the door assembly. Our Batwing® seal is recommended for upgrading fire rated doors. Refer to page 23 for further details.

Sealing for thermal containment

Sealing for smoke also makes a positive contribution to thermal containment between spaces within a building, as well as for external doors; helping in the efficient energy management of a building.

Other considerations - Accessibility

Approved Document M (England and Wales), Technical Booklet R (N. Ireland) and Technical Handbook Section 4 (Scotland) specify the size and location for glazed vision panels in doors in various situations, in order to promote safety and accessibility. Visual contrast on the leading edge of doors is also included, as are opening and closing forces for ease of door operation, height of the threshold plate and door width requirements. In addition to providing acoustic insulation and fire/smoke protection, doors must allow free passage. It's crucial that the sealing system fitted to door assemblies has minimal effect on the opening and closing operation of the assembly.

SEALING AGAINST LEAKAGE

Interrupting a smoke or acoustic door seal at hinges or other ironmongery can seriously reduce its effectiveness, and may even mean that the regulatory requirements will not be met. That's why it's vital to ensure a continuous smoke seal all around the door.

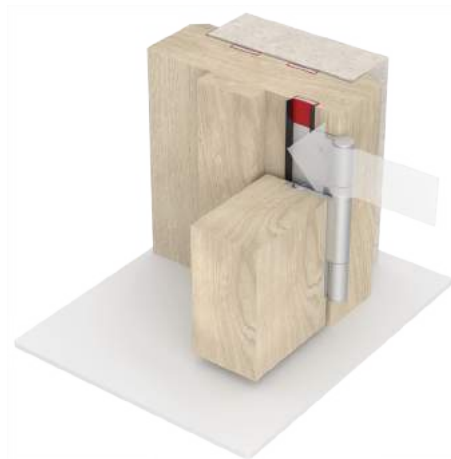

Leakage at hinges

To provide a permanent barrier to smoke and sound it's essential that an effective smoke seal is maintained at the hinges (shown above on the right). If locks are also unprotected the door will not meet regulatory requirements.

Our products are designed to enable an effective smoke and acoustic seal to be maintained.

Leakage at the threshold

A study of smoke and sound behaviour clearly shows that it is not sufficient to seal only the tops and sides of doors. Both cold smoke and sound will transfer to an adjacent compartment through the gap at the threshold. We can supply a range of threshold seals which will provide protection against smoke and when coupled with an effective perimeter seal will meet the requirements of Approved Document E.

For further information on the products please refer to our Lorient Architectural Seals brochure.

BS 9999 (an Approved Document to the Building Regulations for England and Wales) states that if a fire and smoke rated door has a gap of over 3mm at the threshold, then you should fit a threshold seal. Please call our Technical Services team on 01626 834252 for further information.

Other areas of potential smoke leakage

It's essential for glazed vision panels, air transfer grilles and other similar features of a door to be evaluated with regard to smoke leakage. Further information can be found in our following brochures entitled:

- ▶ Fire resistant glazing systems
- ▶ Fire + smoke resistant air transfer grilles
- ▶ Fire resistant door hardware protection.

Back of frame

If not suitably protected, the back of frame can present a risk in the case of a fire. The gap between the frame and wall should be filled with a suitable fire resistant material; we recommend using two LP2004 fire seals (as represented throughout this brochure), for the back of the frame. Further information can be found in BS 8214:2016 Timber-based fire door assemblies. Code of practice.

BUILDING REGULATIONS

The Building Regulations provide guidance as to the minimum building standards to be achieved. They reference the relevant British and European Standards defining the test requirements and performance of the fire door assembly or fire doorset.

There are several aspects of the Buildings Regulations that must be considered in conjunction with each other when specifying and installing fire and smoke resistant door assemblies. The regional variations of the Building Regulations:

	ENGLAND	WALES	SCOTLAND	N.IRELAND	IRELAND
FIRE	Approved Document B	Approved Document B	Technical Handbook 2	Technical Booklet E	Technical Guidance Document B
ACOUSTICS	Approved Document E	Approved Document E	Technical Handbook 5	Technical Booklet G	Technical Guidance Document E
ACCESSIBILITY	Approved Document M	Approved Document M	Technical Handbook 4	Technical Booklet R	Technical Guidance Document M
THERMAL	Approved Document L	Approved Document L	Technical Handbook 6	Technical Booklet F	-

STANDARDS + REGULATIONS

The requirements for fire and smoke containment with regard to 'means of escape' are contained in the following standards:

FIRE + SMOKE

STANDARD	TITLE
BS 476-20:1987	Fire tests on building materials and structures. Method for determination of the fire resistance of elements of construction (general principles)
BS 476-22:1987	Methods for determination of the fire resistance of non-loadbearing elements of construction doorsets and shutter assemblies. Method of measurement under ambient temperature conditions
BS 476-31.1:1983	Fire tests on building materials and structures. Methods for measuring smoke penetration through doorsets and shutter assemblies. Method of measurement under ambient temperature conditions
BS EN 1634-1:2014+A1:2018	Fire resistance and smoke control tests for door and shutter assemblies, openable windows and elements of building hardware. Fire resistance test for door and shutter assemblies and openable windows
BS EN 1634-3:2004	Fire resistance and smoke control tests for door and shutter assemblies, openable windows and elements of building hardware. Smoke control test for door and shutter assemblies
BS 8214:2016	Timber-based fire door assemblies. Code of practice
BS 9999:2017	Code of practice for fire safety in the design, management and use of buildings

ACOUSTIC

STANDARD	TITLE
BS EN ISO 10140-1:2016	Acoustics. Laboratory measurement of sound insulation of building elements. Application rules for specific products
BS EN ISO 717-2:2020	Acoustics. Rating of sound insulation in buildings and of building elements. Impact sound insulation elements of construction
ASTM E413-16	Classification for rating sound insulation building hardware. Smoke control test for door and shutter assemblies

FIRE DOOR RATING

Fire doors are tested to BS 476-22 or BS EN 1634-1 to represent how they will function in a fire, and are rated in minutes and prefixed by the letters FD. The most common specification for fire doors leading to escape routes are fire doors resisting fire for 30 minutes, called FD30 fire doors.

BRITISH STANDARD: MINIMUM FIRE RESISTANCE (INTEGRITY) RATING	EUROPEAN STANDARD: MINIMUM FIRE RESISTANCE (INTEGRITY) RATING	NUMBER OF MINUTES THAT THE DOOR CAN RESIST FIRE
FD30	E30	30 minutes
FD60	E60	60 minutes
FD90	E90	90 minutes
FD120	E120	120 minutes

Sometimes doors are required to be both fire and smoke control (resistant) doors - tested to BS 476-31.1 or EN 1634-3. This means there will be either a combined fire and smoke seal; or a plain intumescent seal along with a separate smoke seal in either the entire perimeter of the door and/or in the frame.

If an air transfer grille (ATG) is required in a fire and smoke control door leaf, it should be fitted with an automatic smoke damper that will close if a fire breaks out.

The 'S' suffix (e.g. FD30S) denotes that the door is both a fire and smoke controlled door.

BRITISH STANDARD: MINIMUM FIRE RESISTANCE (INTEGRITY) RATING	EUROPEAN STANDARD: MINIMUM FIRE RESISTANCE (INTEGRITY) RATING	NUMBER OF MINUTES THAT THE DOOR CAN RESIST FIRE + SMOKE
FD30S	E30S	30 minutes
FD60S	E60S	60 minutes
FD90S	E90S	90 minutes
FD120S	E120S	120 minutes

SOUND CONTAINMENT

Wherever noise influences human activity, effective acoustic sealing is essential. Whether preserving the confidentiality of discussions in a private office or doctor's surgery, or reducing noise from adjacent rooms in hotels; preservation of privacy is paramount. Legislation is in place that provides guidelines for acoustic performance of door assemblies in a number of situations.

ACOUSTIC RATING	LOCATION	REGULATIONS
29dB Rw	Dwelling houses, flats and rooms for residential purposes	Approved Document E
30dB Rw	Schools: all spaces except music rooms	Building Bulletin 93 "The Acoustic Design of Schools"
35dB Rw	School music rooms	Building Bulletin 93 "The Acoustic Design of Schools"



Approved Document E and Building Bulletin 93 for Schools

PRODUCT SELECTOR

We have a fantastic range of intumescent fire seals; most of the door seals are multi-functional and provide protection against fire, smoke and sound leakage. These seals are used in the top and vertical sides of door leaves, or in the frame. The bottom of the door should be sealed with a threshold seal from our architectural seals range.

PRODUCT	Certification				Test evidence			PAGE
	CERTIFIRE	BBA	IFC	UL				
FINESSE™	CF330 + CF341	92/2841	FRPP454	-	▲	▲	▲	16
DS SEAL	CF330 + CF341	92/2841	FRPP454	-	▲	▲	▲	17
TS SEAL	CF330 + CF341	92/2841	FRPP454	-	▲	▲	▲	18
AS SEAL	CF330 + CF341	92/2841	FRPP454	-	▲	▲	▲	19
SS SEAL	CF330 + CF341	92/2841	FRPP454	-	▲	▲		20
FIRE SEAL	CF330 + CF341	92/2841	FRPP454	-	▲			21
LAS1007	-	-	-	R27972		▲	▲	22
LAS1206	-	-	-	R27972		▲	▲	22
LAS1010	CF5179	-	-	R27972		▲	▲	23
LAS1015	CF5179	-	-	R27972		▲	▲	23
LAS1212	CF5179	92/2841	-	R27972		▲	▲	23
LAS1206K	-	-	-	R27972		▲	▲	24
LAS1212K	CF5179	92/2841	-	R27972		▲	▲	24
LAS1011	CF5179	-	-	R27972		▲	▲	25
LAS1016	-	-	-	-		▲	▲	25

FINESSE™ SEALS

DS SEALS

TS SEALS

AS SEALS

SS SEALS

FIRE SEAL

BATWING®

SINGLE BATWING®

BATWING® -ON-A-STICK

LAS1011 FIRTREE®

LAS1016 FIRTREE®







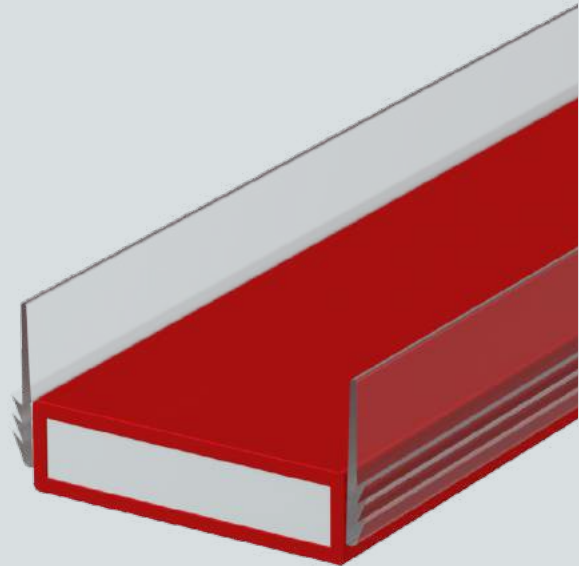













ACOUSTIC, SMOKE + FIRE DOOR SEALS

Gaps around the four sides of a fire door leaf are essential – it's the only way the door can open and close. But these gaps create a point of weakness, where fire can take hold and destroy the door, and lethal smoke can pass through.

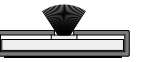
Lorient's intumescent seals protect those gaps. Most of the door seals shown in this section are multi-functional and provide protection against fire, smoke, sound leakage and heat loss. These seals are used in the top and vertical sides of door leaves, or in the frame. The bottom of the door should be sealed with a threshold seal from our architectural seals range.

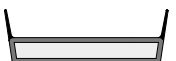

INTUMESCENT SEALS

	FINESSE™	DS SEAL	TS SEAL	AS SEAL	SS SEAL	FIRE SEAL
	A double-fin solution for acoustic, smoke + fire protection with superior aesthetics	A double-fin solution for acoustic, smoke + fire containment	A double-fin solution for acoustic, smoke + fire containment	A single-fin solution for acoustic, smoke + fire containment	A brush seal solution for smoke + fire containment	Intumescent fire seal for where no smoke sealing is required
10 X 4MM SEALS	-	 LP1004DS	 LP1004TS	 LP1004AS	 LP1004SS	 LP1004
15 X 4MM SEALS	 LP1504 Finesse™	 LP1504DS	 LP1504TS	 LP1504AS	 LP1504SS	 LP1504
20 X 4MM SEALS	 LP2004 Finesse™	 LP2004DS	 LP2004TS	 LP2004AS	 LP2004SS	 LP2004
25 X 4MM SEALS	-	 LP2504DS	 LP2504TS	 LP2504AS	 LP2504SS	 LP2504
SMOKE SEAL MATERIAL	Elastomeric fins 4mm	Elastomeric fins 4mm	Elastomeric fins 4mm	Elastomeric fin 4mm	Polypropylene brush pile 4mm	-
MIN / MAX GAP SIZES	3mm/4mm	3mm/4mm	3mm/4mm	3mm/4mm	3mm/4mm	3mm/4mm
SEAL SIZES	All seals are available in standard lengths of 1m and 2.1m. Other lengths are available to special order. We can also produce non-standard fire seals ranging from 10mm – 70mm wide (MOQ, charges and lead times apply).					
FINISH	All our acoustic, smoke and fire seals are available in a range of standard and special colours – see the colour details on pages 44 - 47.					
FITTING	All our intumescent fire seals have a heavy duty self-adhesive backing. The adhesive used has been specially selected to provide excellent adhesion on a wide range of materials, including MDF on which it is usually difficult to obtain an effective bond. Make sure grooves are free from dust and grease. Lorient does not recommend oil or solvent based paint/primer					

FINESSE™ SEALS

LP1504 Finesse™, LP2004 Finesse™

The Finesse™ seal offers the ultimate in acoustic, smoke and fire protection. This high-class seal offers performance and durability with a truly superb appearance. With clear fins as standard, it's ideal for luxury installations, where aesthetics are paramount. The seal is available in a range of sizes to cover 30 and 60 minute applications.



ACOUSTIC, SMOKE + FIRE SEALS

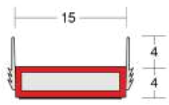

LP1504 Finesse™

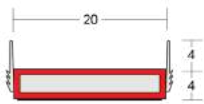

LP2004 Finesse™



FD30 example:
Finesse™ offset to comply with Certifire CF341/330 (Shown with LAS8001 si)



FD60 example:
Finesse™ (Shown with LP1504 fire seal & LAS8001 si + cladding kit)

▶▶ **Note:** It's essential to consult the manufacturer to determine exactly what configuration of seal & size of seal have been tested.

SYSTEM SPECIFICATIONS

Test evidence

- ▶ Fire: BS 476-22:1987.
- ▶ Fire: BS EN 1634-1:2008.
- ▶ Smoke: BS 476-31.1:1983.
- ▶ Assessment: CNA/F14171.
- ▶ Acoustic: BS EN ISO 10140-2:2010.
- ▶ Durability: 100,000 cycles.

Performance

- ▶ Meets smoke requirements BS 9999:2017.
- ▶ Protects against sound, smoke, and fire.
- ▶ Low frictional resistance for ease of door operation.

Location

- ▶ Single and double leaf doors.

Size

- ▶ 15 x 4mm, 20 x 4mm.

Use with

- ▶ Any architectural seals.

Min/max gap size

- ▶ 3mm/4mm.

Seal material

- ▶ PVC encased sodium silicate and flexible elastomeric fins.

Standard lengths

- ▶ 1m and 2.1m.
- ▶ Other lengths to special order.

Fixing

- ▶ Heavy duty self-adhesive backing tape.

Finishes

- ▶ Available in a range of standard & non-standard colours, plus woodgrain finishes available to special order.
- ▶ Clear fins as standard.

Certification

DS SEALS

LP1004DS, LP1504DS, LP2004DS, LP2504DS

Our DS door seal offers the ultimate in acoustic, smoke + fire protection. Its unique design means that whichever way round the product is installed, the seal can always be fitted in the correct place, maintaining the integrity of the acoustic + smoke seal at the ironmongery points. Available in a range of sizes to cover 30, 60, 90 + 120 minute applications.

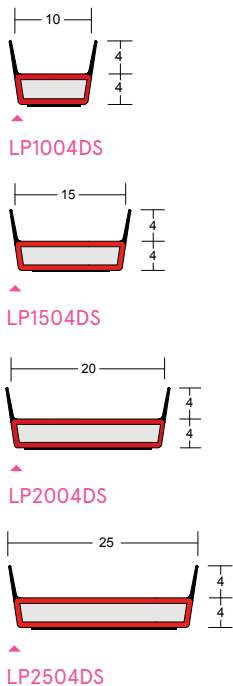

▲ **FD30 example:**
DS seal offset to comply with Certifire CF341/330 (Shown with LAS8001 si)



▲ **FD60 example:**
DS seal (Shown with LP1504 fire seal & LAS8001 si + cladding kit)

▶ **Note:** It's essential to consult the manufacturer to determine exactly what configuration of seal & size of seal have been tested.

ACOUSTIC, SMOKE + FIRE SEALS

SYSTEM SPECIFICATIONS

Test evidence

- ▶ Fire: BS 476-22:1987.
- ▶ Fire: BS EN 1634-1:2008.
- ▶ Smoke: BS 476-31.1:1983.
- ▶ Assessment: CNA/F14171.
- ▶ Acoustic: BS EN ISO 10140-2:2010.
- ▶ Durability: 100,000 cycles.

Performance

- ▶ Meets smoke requirements BS 9999:2017.
- ▶ Protects against sound, smoke, and fire.
- ▶ Low frictional resistance for ease of door operation.

Location

- ▶ Single and double leaf doors.

Size

- ▶ 10 x 4mm, 15 x 4mm, 20 x 4mm, 25 x 4mm.
- ▶ Other sizes available, please ask for details.

Use with

- ▶ Any architectural seals.

Min/max gap size

- ▶ 3mm/4mm.

Seal material

- ▶ PVC encased sodium silicate and flexible elastomeric fins.

Standard lengths

- ▶ 1m and 2.1m.
- ▶ Other lengths to special order.

Fixing

- ▶ Heavy duty self-adhesive backing tape.

Finishes

- ▶ Available in a range of standard & non-standard colours, with black fins.

Certification

TS SEALS

LP1004TS LP1504TS, LP2004TS, LP2504TS

Our TS door seal with double elastomeric fins offers acoustic, smoke + fire protection. Available in a choice of sizes to cover 30 and 60 minute applications.



ACOUSTIC, SMOKE + FIRE SEALS

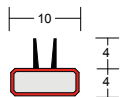

LP1004TS

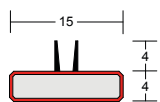

LP1504TS



LP2004TS

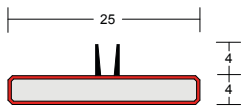

LP2504TS



FD30 example:
TS seal with Batwing® to comply with BS 9999 (Shown with LAS8001 si)



FD60 example:
TS seal (Shown with with LP1504 fire seal & LAS8001 si + cladding kit)

▶▶ **Note:** It's essential to consult the manufacturer to determine exactly what configuration of seal & size of seal have been tested.

SYSTEM SPECIFICATIONS

Test evidence

- ▶ Fire: BS 476-22:1987.
- ▶ Fire: BS EN 1634-1:2008.
- ▶ Smoke: BS 476-31.1:1983.
- ▶ Assessment: CNA/F14171.
- ▶ Acoustic: BS EN ISO 10140-2:2010.
- ▶ Durability: 100,000 cycles.

Performance

- ▶ Meets smoke requirements BS 9999:2017.
- ▶ Protects against sound, smoke, and fire.
- ▶ Low frictional resistance for ease of door operation.

Location

- ▶ Single and double leaf doors.

Size

- ▶ 10 x 4mm, 15 x 4mm, 20 x 4mm, 25 x 4mm.
- ▶ Other sizes available, please ask for details.

Use with

- ▶ Any architectural seals.

Seal material

- ▶ PVC encased sodium silicate and flexible elastomeric fins.

Min/max gap size

- ▶ 3mm/4mm.

Fixing

- ▶ Heavy duty self-adhesive backing tape.

Standard lengths

- ▶ 1m and 2.1m.
- ▶ Other lengths to special order.

Finishes

- ▶ Available in a range of standard & non-standard colours, plus woodgrain finishes available to special order.
- ▶ Black fins as standard.

Certification

AS SEALS

LP1004AS, LP1504AS, LP2004AS, LP2504AS

Our AS door seal with elastomeric fin offers acoustic, smoke + fire protection. Available in a choice of sizes to cover 30 + 60 minute applications.

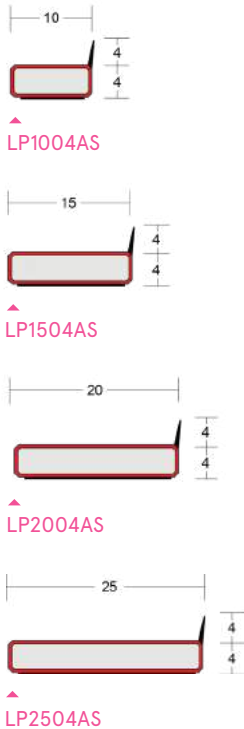

▲ **FD30 example:**
AS seal with Batwing® to comply with BS 9999 (Shown with LAS8001 si)



▲ **FD60 example:**
AS seal (Shown with LP1504 fire seal & LAS8001 si + cladding kit)

▶ **Note:** It's essential to consult the manufacturer to determine exactly what configuration of seal & size of seal have been tested.

ACOUSTIC, SMOKE + FIRE SEALS

SYSTEM SPECIFICATIONS

Test evidence

- ▶ Fire: BS 476-22:1987.
- ▶ Fire: BS EN 1634-1:2008.
- ▶ Smoke: BS 476-31.1:1983.
- ▶ Assessment: CNA/F14171.
- ▶ Acoustic: BS EN ISO 10140-2:2010.
- ▶ Durability: 100,000 cycles.

Performance

- ▶ Meets smoke requirements BS 9999:2017.
- ▶ Protects against sound, smoke, and fire.
- ▶ Low frictional resistance for ease of door operation.

Location

- ▶ Single and double leaf doors.

Size

- ▶ 10 x 4mm, 15 x 4mm, 20 x 4mm, 25 x 4mm.
- ▶ Other sizes available, please ask for details.

Use with

- ▶ Any architectural seals.

Min/max gap size

- ▶ 3mm/4mm.

Seal material

- ▶ PVC encased sodium silicate and flexible elastomeric fin.

Fixing

- ▶ Heavy duty self-adhesive backing tape.

Standard lengths

- ▶ 1m and 2.1m.
- ▶ Other lengths to special order.

Finishes

- ▶ Available in a range of standard & non-standard colours, with black fins.
- ▶ Black fins as standard.

Certification

FIRE + SMOKE SEALS

SS SEALS

LP1004SS, LP1504SS, LP2004SS, LP2504SS

Our SS door seal with polypropylene brush pile offers fire + smoke protection. Available in a choice of sizes to cover 30 + 60 minute applications.



ACOUSTIC, SMOKE + FIRE SEALS

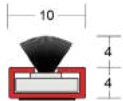

LP1004SS

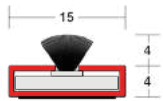

LP1504SS



LP2004SS

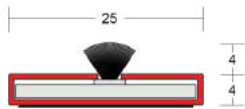

LP2504SS



FD30 example:
SS seal with Batwing® to comply with BS 9999 (Shown with LAS8001 si + Batwing®)



FD60 example:
SS seal (Shown with with LP1504 fire seal & LAS8001 si + cladding kit)

▶▶ **Note:** It's essential to consult the manufacturer to determine exactly what configuration of seal & size of seal have been tested.

SYSTEM SPECIFICATIONS

Test evidence

- ▶ Fire: BS 476-22:1987.
- ▶ Fire: BS EN 1634-1:2008.
- ▶ Smoke: BS 476-31.1:1983.
- ▶ Assessment: CNA/F14171.
- ▶ Durability: 100,000 cycles.

Performance

- ▶ Meets smoke requirements BS 9999:2017.
- ▶ Protects against smoke and fire.
- ▶ Low frictional resistance for ease of door operation.

Location

- ▶ Single and double leaf doors.

Size

- ▶ 10 x 4mm, 15 x 4mm, 20 x 4mm, 25 x 4mm.
- ▶ Other sizes available, please ask for details.

Use with

- ▶ Any architectural seals.

Min/max gap size

- ▶ 3mm/4mm.

Seal material

- ▶ PVC encased sodium silicate and polypropylene brush pile.

Standard lengths

- ▶ 1m and 2.1m.
- ▶ Other lengths to special order.

Fixing

- ▶ Heavy duty self-adhesive backing tape.

Finishes

- ▶ Available in a range of standard & non-standard colours, plus woodgrain finishes available to special order.
- ▶ Black brush as standard.

Certification

FIRE SEALS

FIRE SEALS

LP1004, LP1504, LP2004, LP2504

Our intumescent fire door seals offer fire protection where no smoke sealing is required. Combine a fire seal with a Batwing® seal for acoustic + smoke containment. Available in a choice of sizes to cover 30 + 60 minute applications.

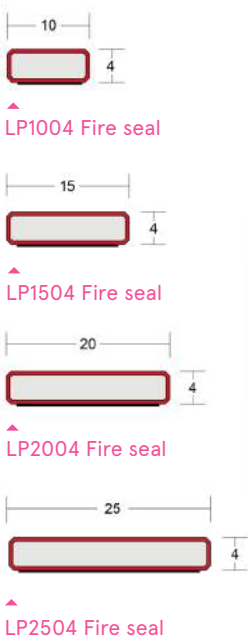

FD30 example:
Fire seal with Batwing® to comply with BS 9999 (Shown with LAS8001 si)



FD60 example:
Fire seal with Batwing® to comply with BS 9999 (Shown with LAS8001 si + cladding kit)



Note: It's essential to consult the manufacturer to determine exactly what configuration of seal & size of seal have been tested.

ACOUSTIC, SMOKE + FIRE SEALS

SYSTEM SPECIFICATIONS

Test evidence

- ▶ Fire: BS 476-22:1987.
- ▶ Fire: BS EN 1634-1:2008.
- ▶ Assessment: CNA/F14171.

Performance

- ▶ Protects against fire.

Location

- ▶ Single and double leaf doors.

Size

- ▶ 10 x 4mm, 15 x 4mm, 20 x 4mm, 25 x 4mm.
- ▶ Other sizes available, please ask for details.

Use with

- ▶ Any architectural seals.

Min/max gap size

- ▶ 3mm/4mm.

Seal material

- ▶ PVC encased sodium silicate.

Standard lengths

- ▶ 1m and 2.1m.
- ▶ Other lengths to special order.

Fixing

- ▶ Heavy duty self-adhesive backing tape.

Finishes

- ▶ Available in a range of standard & non-standard colours, plus woodgrain finishes available to special order.

Certification

PERIMETER SEALS

LAS1007 & LAS1206 Single Batwing®

MEDIUM DUTY

Medium duty, acoustic and smoke perimeter seals; which minimise the opening and closing resistance of the door leaf due to their unique, curved fins. Flexible elastomeric fin material springs back to original shape to provide ongoing performance and durability in service. They can be fitted with minimal disruption to the door assembly.



ACOUSTIC, SMOKE + FIRE SEALS



▲ LAS1206
Single
Batwing®



▲ LAS1007
Single
Batwing®

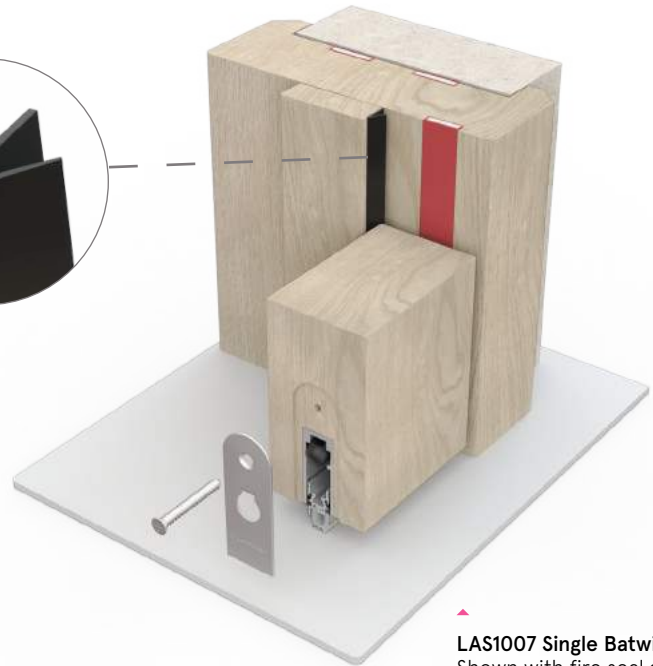
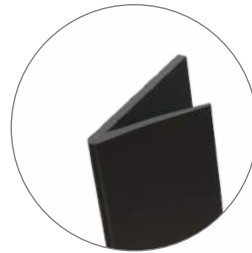

▲ LAS1007 Single Batwing®
Shown with fire seal as
referenced in CNA/F14171
(also shown with LAS8001 si)

SYSTEM SPECIFICATIONS

Test evidence

- ▶ Smoke: BS 476-31.1:1983.
- ▶ Acoustic: BS EN ISO 10140-2: 2010 (up to Rw 34dB).
- ▶ Durability: 100,000 cycles.

Performance

- ▶ Meets smoke requirement: BS 9999:2017.
- ▶ Protects against sound, smoke, draught and light.

Location

- ▶ Head and jambs of single and double leaf doors.

Use with

- ▶ Any fire seals or architectural seals.

Min/max gap size

- ▶ 3mm/4mm.

Seal material

- ▶ Co-extruded rigid back PVC with flexible fins.

Standard lengths

- ▶ 1m and 2.1m.
- ▶ Single doorset pack consisting of 1 x 1m and 2 x 2.1m.
- ▶ Other lengths to special order.

Fixing

- ▶ Heavy duty self-adhesive backing tape.

Colours

- ▶ Black, white, dark brown, light brown and grey as standard.
- ▶ Silver, cream, red and clear available to special order.
- ▶ Note: clear Batwing® will not prevent light penetration.

Certification

PERIMETER SEALS

LAS1010, LAS1212, LAS1015 Batwing®

MEDIUM DUTY

Medium duty, acoustic and smoke perimeter seals; which minimise the opening and closing resistance of the door leaf due to their unique, curved fins. Flexible elastomeric fin material springs back to original shape to provide ongoing performance and durability in service. They can be fitted with minimal disruption to the door assembly.

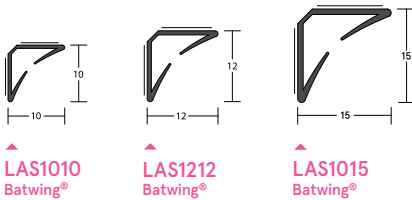

▲ LAS1010
Batwing®

▲ LAS1212
Batwing®

▲ LAS1015
Batwing®



▲ LAS1212 Batwing®
Shown with fire seal as
referenced in CNA/F14171
(also shown with LAS8001 si)

ACOUSTIC, SMOKE + FIRE SEALS

SYSTEM SPECIFICATIONS

Test evidence

- ▶ Smoke: BS 476-31.1:1983.
- ▶ Smoke: BS EN 1634-3:2004 (LAS1212).
- ▶ Acoustic: BS EN ISO 10140-2:2010 (up to Rw 44dB).
- ▶ Durability: 100,000 cycles.

Performance

- ▶ Meets smoke requirement: BS 9999:2017.
- ▶ Protects against sound, smoke, draught and light.

Location

- ▶ Head and jambs of single and double leaf doors.

Use with

- ▶ Any fire seals or architectural seals.

Min/max gap size

- ▶ 3mm/4mm.

Seal material

- ▶ Co-extruded rigid back PVC with flexible fins.

Standard lengths

- ▶ 1m and 2.1m.
- ▶ Single doorset pack consisting of 1 x 1m and 2 x 2.1m.
- ▶ Other lengths to special order.

Fixing

- ▶ Heavy duty self-adhesive backing tape.

Colours

- ▶ Black, white, dark brown, light brown and grey as standard.
- ▶ Silver, cream, red and clear available to special order.
- ▶ Note: clear Batwing® will not prevent light penetration.

Certification

LAS1212

PERIMETER SEALS

LAS1206K & LAS1212K Batwing® on-a-stick

MEDIUM DUTY

Medium duty, acoustic and smoke perimeter seals; which minimise the opening and closing resistance of the door leaf due to their unique, curved fins. Flexible elastomeric fin material springs back to original shape to provide ongoing performance and durability in service. They can be fitted with minimal disruption to the door assembly.



ACOUSTIC, SMOKE + FIRE SEALS

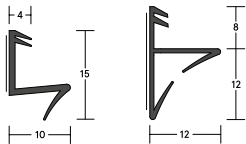

▲ LAS1206K
Batwing®
on-a-stick

▲ LAS1212K
Batwing®
on-a-stick



▲ LAS1212K Batwing®
Shown with fire seal as
referenced in CNA/F14171
(also shown with LAS8001 si)

SYSTEM SPECIFICATIONS

Test evidence

- ▶ Smoke: BS 476-31.1:1983.
- ▶ Acoustic: BS EN ISO 10140-2:2010 (up to Rw 37dB).
- ▶ Durability: 100,000 cycles.

Performance

- ▶ Meets smoke requirement: BS 9999:2017.
- ▶ Protects against sound, smoke, draught and light.

Location

- ▶ Head and jambs of single and double leaf doors.

Use with

- ▶ Any fire seals or architectural seals.

Min/max gap size

- ▶ 3mm/4mm.

Seal material

- ▶ Co-extruded rigid back PVC with flexible fins.

Standard lengths

- ▶ 1m and 2.1m.
- ▶ Single doorset pack consisting of 1 x 1m and 2 x 2.1m.
- ▶ Other lengths to special order.

Fixing

- ▶ Heavy duty self-adhesive backing tape.
- ▶ Groove size for LAS1206K is 3mm x 11mm.
- ▶ Groove size for LAS1212K is 3mm x 9mm.

Colours

- ▶ Black, white, dark brown, light brown and grey as standard.
- ▶ Silver, cream, red and clear available to special order.
- ▶ Note: clear Batwing® will not prevent light penetration.

Certification

PERIMETER SEALS

LAS1011 & LAS1016 Firtree™

MEDIUM DUTY

Highly effective acoustic seals, which also provide additional cold smoke protection around the perimeter of fire rated doors. Flexible and durable. They can be fitted with minimal disruption to the door assembly.

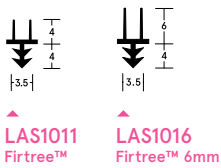

▲ LAS1011
Firtree™

▲ LAS1016
Firtree™ 6mm

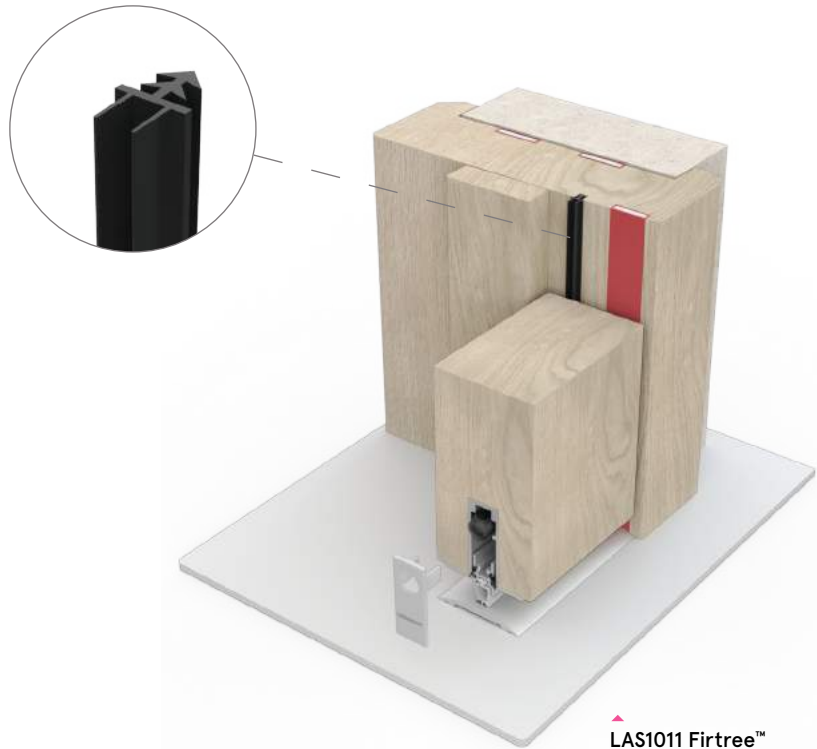

ACOUSTIC, SMOKE + FIRE SEALS

▲ LAS1011 Firtree™
Shown with fire seal as referenced in CNA/F14171 (shown with LAS8005 si + LAS4002)

SYSTEM SPECIFICATIONS

Test evidence

- ▶ Smoke: BS 476-31.1:1983.
- ▶ Acoustic: BS EN ISO 10140-2:2010 (up to Rw 40dB).
- ▶ Durability: 100,000 cycles.

Performance

- ▶ Meets smoke requirement: BS 9999:2017.
- ▶ Protects against sound, smoke, draught and light.

Location

- ▶ Head and jambs of single and double leaf doors. May also be used at the threshold when combined with a threshold plate.

Use with

- ▶ Any fire seals or architectural seals.

Min/max gap size

- ▶ 3mm/4mm (LAS1011).
- ▶ 4mm/6mm (LAS1016).

Seal material

- ▶ Co-extruded rigid back PVC with flexible fins.

Standard lengths

- ▶ 1m and 2.1m. Other lengths to special order.

Fixing

- ▶ Groove size is 3mm x 4mm.

Colours

- ▶ Black or white as standard.
- ▶ Dark brown and light brown available to special order.

Certification

APPLICATION DETAILS

The following pages show how our seals can be used to achieve the levels of protection against sound, smoke and fire required by Building Regulations and British Standard codes of practice.

The examples shown result from many years' experience and hundreds of fire, smoke and sound tests.

Our seals give equal performance whether placed in the door leaf or the frame, but it's preferable to fit them in the frame where they will not interfere with any size adjustments which may subsequently be made to the door leaf. However, it's essential to consult the manufacturer to determine exactly what configuration of seal has been tested.

A third party certificated timber doorset is the best guarantee that all elements, acoustic, smoke and fire seals, glazing and ironmongery are fully tested to the relevant standards.

The following illustrations are a selection of our recommended solutions for achieving fire protection of up to 60 minutes. However, it's possible to achieve fire protection beyond this level.

For more information on further solutions from our product range, please call our Technical Services team on +44 (0) 1626 834252.

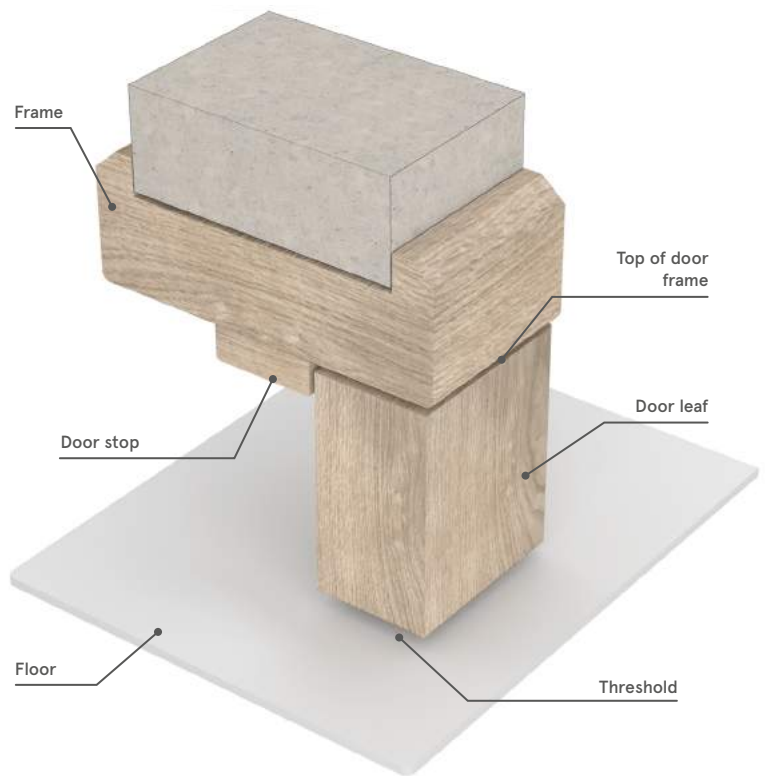

Door configurations

Different door configurations need different sealing systems. That's because doors and seals work together, and different doors have different areas of strength and weakness that the seals need to complement.

Single leaf and double leaf doors behave very differently: you should never assume that a sealing system for single leaf doors will give the same performance on double leaf doors. Some common door configurations are shown below.

SINGLE LEAF DOORS

Single acting / hinged

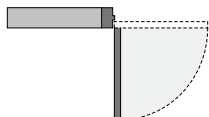



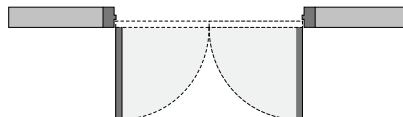

DOUBLE LEAF DOORS

Single acting / hinged
Rebated / unrebated meeting stiles



APPLICATION DETAILS

dB Rating	Fire Rating	Door configuration		Sealing system				Protection			Page	
		Door	Thickness	Perimeter	Meeting Stile	Glazing Seal	Threshold					
30dB	FD30	Single	44mm	LAS1504DS	—	—	LAS8001 si LAS4002i	▲	▲	▲	ID120	28
30dB	FD30	Single	44mm	LAS7001 si LP1504	—	—	LAS8001 si LAS4002	▲	▲	▲	ID122	29
30dB	FD30	Single	44mm	LP1504 Finesse™	—	—	LAS8002 si	▲	▲	▲	ID277	30
32dB	FD30	Single	44mm	LAS1212 LP1504	—	—	LAS8001 si LAS4011	▲	▲	▲	ID415	31
31dB	FD30	Single	44mm	LAS1212 LP1504DS	—	System-36/7 PLUS	LAS8001 si	▲	▲	▲	ID509	32
32dB	FD30	Single	44mm	LAS1212K LP1504DS	—	FF1	LAS8001 si	▲	▲	▲	ID55	33
31dB	FD30	Double	44mm	LAS1212 LP1504	LP1004 x 2 LAS1011 x 2	—	LAS8002 si LAS4011	▲	▲	▲	ID352	34
32dB	FD30	Double	44mm	LAS1212 LP1504 LP1504DS	LP1004DS LP1004	—	LAS8001 si LAS4011	▲	▲	▲	ID436	35
33dB	FD60	Single	54mm	LP1504 Finesse™ LP1504	—	—	LAS8001 si with cladding kit	▲	▲	▲	ID483	36
35dB	FD60	Single	54mm	LP1504DS x 2	—	—	LAS8001 si with cladding kit	▲	▲	▲	ID602	37
35dB	FD60	Single	54mm	LAS1212 LP1504 LP1504DS	—	—	LAS8001 si with cladding kit	▲	▲	▲	ID485	38
35dB	FD60	Single	54mm	LP1504DS LP1504	—	System-36/15 PLUS	LAS8001 si with cladding kit	▲	▲	▲	ID68	39
32dB	FD60	Double	54mm	LAS1212 LP1504 LP1504DS	LP1504DS x 2 LAS9010 with cladding kit	RF1	LAS8001 si with cladding kit LAS4014 si	▲	▲	▲	ID679	40
35dB	FD60	Double	54mm	LAS1212 LP1504 LP1504DS	LP1504DS x 2	—	LAS1016 x 2 AAS4508 si	▲	▲	▲	ID156	41

Find acoustic solutions in our online Acoustic
Search app: lorientuk.com/acousticsearch



30dB

LP1504DS, LAS4002 & LAS8001 si

SINGLE LEAF | SINGLE SWING | 44MM |
UNGLAZED | PARTICLE BOARD



FIRE RATED DOORS - 30 MINUTES

Product	Description	Key Features	Location	Performance
1 LP1504DS	Combined acoustic, smoke & fire seal	<ul style="list-style-type: none"> ▶ Low friction for ease of door operation ▶ Offers continuous smoke seal 	Jambs & head	Acoustic Smoke BS EN ISO 10140-2:2010 BS 476-31.1:1983 BS 9999 Fire BS 476-20/22:1987 BS EN 1634-1:2014 Durability 100,000 cycles CERTIFIRE CF341, CF330
2 LAS4002	Low-profile slimline threshold plate	<ul style="list-style-type: none"> ▶ Only 5mm high ideal for wheeled traffic ▶ Works with any threshold seal 	Threshold	UL R27972
3 LAS8001 si	Drop seal	<ul style="list-style-type: none"> ▶ Mechanism lifts the seal clear of the floor when opened ▶ Self-levelling works on uneven floors 	Threshold	Acoustic Smoke BS EN ISO 10140-2:2010 BS 476-31.1:1983 BS EN 1634-3:2004 BS 9999 Fire BS 476-20/22:1987 BS EN 1634-1:2014 Durability 100,000 cycles CERTIFIRE CF5179 UL R27972
4 LP2004 (x2)	Fire seals	<ul style="list-style-type: none"> ▶ Easy to fit 	Back of frame	Fire BS 476-20/22:1987 CERTIFIRE CF341, CF330

30dB

LAS7001 SI, LP1504, LAS4002 & LAS8001 si

SINGLE LEAF | SINGLE SWING | 44MM |
7MM PYRODUR PLUS | PARTICLE BOARD



FIRE RATED DOORS - 30 MINUTES

Product	Description	Key Features	Location	Performance
1 LAS7001 si	Perimeter seal	<ul style="list-style-type: none"> Designed to be fitted to door stops 	Jambs & head	Acoustic BS EN ISO 10140-2:2010 Smoke BS 476-31.1:1983 Durability 100,000 cycles CERTIFIRE CF5179 UL R27972
2 LP1504	Fire seal	<ul style="list-style-type: none"> Easy to fit 	Jambs & head	Fire BS 476-20/22:1987 CERTIFIRE CF341, CF330
3 LAS4002	Low-profile slimline threshold plate	<ul style="list-style-type: none"> Only 5mm high ideal for wheeled traffic Works with any threshold seal 	Threshold	UL R27972
4 LAS8001 si	Drop seal	<ul style="list-style-type: none"> Mechanism lifts the seal clear of the floor when opened Self-levelling works on uneven floors 	Threshold	Acoustic BS EN ISO 10140-2:2010 Smoke BS 476-31.1:1983 BS EN 1634-3:2004 BS 9999 Fire BS 476-20/22:1987 BS EN 1634-1:2014 Durability 100,000 cycles CERTIFIRE CF5179 UL R27972
5 LP2004 (x2)	Fire seals	<ul style="list-style-type: none"> Easy to fit 	Back of frame	Fire BS 476-20/22:1987 CERTIFIRE CF341, CF330



30dB

LP1504 Finesse™ & LAS8002 si

SINGLE LEAF | SINGLE SWING | 44MM |
UNGLAZED | PARTICLE BOARD



FIRE RATED DOORS - 30 MINUTES

Product	Description	Key Features	Location	Performance
2 LP1504 Finesse™	Combined acoustic, smoke & fire seal	<ul style="list-style-type: none"> ▶ Low friction for ease of door operation ▶ Offers continuous smoke seal 	Jambs & head	Acoustic Smoke BS EN ISO 10140-2:2010 BS 476-31.1:1983 BS 9999 Fire BS 476-20/22:1987 BS EN 1634-1:2014 Durability CERTIFIRE 100,000 cycles CF341, CF330
2 LAS8002 si	Drop seal	<ul style="list-style-type: none"> ▶ Mechanism lifts the seal clear of the floor when opened ▶ Self-levelling works on uneven floors 	Threshold	Acoustic Smoke BS EN ISO 10140-2:2010 BS 476-31.1:1983 BS EN 1634-3:2004 BS 9999 Fire BS 476-20/22:1987 BS EN 1634-1:2014 Durability CERTIFIRE 100,000 cycles CF5179 UL R27972
3 LP2004 (x2)	Fire seals	<ul style="list-style-type: none"> ▶ Easy to fit 	Back of frame	Fire CERTIFIRE BS 476-20/22:1987 CF341, CF330

32dB

LAS1212, LP1504, LAS4011 & LAS8001 si

SINGLE LEAF | SINGLE SWING | 44MM |
UNGLAZED | PARTICLE BOARD



FIRE RATED DOORS - 30 MINUTES

Product	Description	Key Features	Location	Performance
1 LAS1212 Batwing®	Acoustic & smoke perimeter seal	<ul style="list-style-type: none"> ▶ Curved fin shape minimises open/closing resistance ▶ Can be fitted with minimal disruption to door 	Jambs & head	Acoustic BS EN ISO 10140-2:2010 Smoke BS 476-31.1:1983 Durability 100,000 cycles CERTIFIRE CF5179 UL R27972
2 LP1504	Fire seal	<ul style="list-style-type: none"> ▶ Easy to fit 	Jambs & head	Fire BS 476-20/22:1987 CERTIFIRE CF341, CF330
3 LAS4011	Low profile threshold plate	<ul style="list-style-type: none"> ▶ Only 6mm high ideal for wheeled traffic ▶ Works with any threshold seal 	Threshold	UL R27972
4 LAS8001 si	Drop seal	<ul style="list-style-type: none"> ▶ Mechanism lifts the seal clear of the floor when opened ▶ Self-levelling works on uneven floors 	Threshold	Acoustic BS EN ISO 10140-2:2010 Smoke BS 476-31.1:1983 BS EN 1634-3:2004 BS 9999 Fire BS 476-20/22:1987 BS EN 1634-1:2014 Durability 100,000 cycles CERTIFIRE CF5179 UL R27972
5 LP2004 (x2)	Fire seals	<ul style="list-style-type: none"> ▶ Easy to fit 	Back of frame	Fire BS 476-20/22:1987 CERTIFIRE CF341, CF330

31dB

LAS1212, LP1504DS, System-36/7 PLUS & LAS8001 si

SINGLE LEAF | SINGLE SWING | 44MM |
7MM PYRODUR PLUS | FR ACOUSTIC CORE

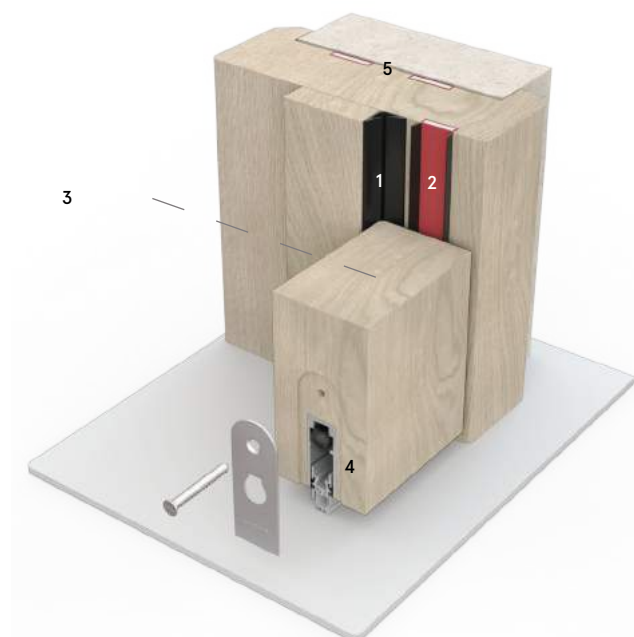

FIRE RATED DOORS - 30 MINUTES

Product	Description	Key Features	Location	Performance
1 LAS1212 Batwing®	Acoustic & smoke perimeter seal	<ul style="list-style-type: none"> ▶ Curved fin shape minimises open/closing resistance ▶ Can be fitted with minimal disruption to door 	Jambs & head	Acoustic Smoke BS EN ISO 10140-2:2010 BS 476-31.1:1983 BS EN 1634-3:2004 Durability CERTIFIRE 100,000 cycles CF5179 UL R27972
2 LP1504DS	Combined acoustic, smoke & fire seal	<ul style="list-style-type: none"> ▶ Low friction for ease of door operation ▶ Offers continuous smoke seal 	Jambs & head	Acoustic Smoke BS EN ISO 10140-2:2010 BS 476-31.1:1983 BS 9999 Fire BS 476-20/22:1987 BS EN 1634-1:2014 Durability CERTIFIRE 100,000 cycles CF341, CF330
3 System-36/7 PLUS	Flexible U-shaped intumescent gasket for 30 minute fire resistant doors/screens	<ul style="list-style-type: none"> ▶ Suitable for use with range of standard fixing beads ▶ Flexible enough to be fitted to curved corners & circular vision panels 	Glazing seal	Fire Smoke CERTIFIRE Glass type BS 476-20/22:1987 BS EN 1634-1:2008 CF5060 Pyrodur Plus 1700 x 300 x 7mm
3 LAS8001 si	Drop seal	<ul style="list-style-type: none"> ▶ Mechanism lifts the seal clear of the floor when opened ▶ Self-levelling works on uneven floors 	Threshold	Acoustic Smoke BS EN ISO 10140-2:2010 BS 476-31.1:1983 BS EN 1634-3:2004 BS 9999 Fire BS 476-20/22:1987 BS EN 1634-1:2014 Durability CERTIFIRE 100,000 cycles CF5179 UL R27972
4 LP2004 (x2)	Fire seals	<ul style="list-style-type: none"> ▶ Easy to fit 	Back of frame	Fire CERTIFIRE BS 476-20/22:1987 CF341, CF330

32dB

LAS1212K, LP1504DS, FF1 & LAS8001 si

SINGLE LEAF | SINGLE SWING | 44MM |
7MM PYROGUARD | LAMINATED SOFTWOOD



FIRE RATED DOORS - 30 MINUTES

Product	Description	Key Features	Location	Performance
1 LAS1212K Batwing®-on-a-stick	Acoustic & smoke perimeter seal	<ul style="list-style-type: none"> ▶ Curved fin shape minimises open/closing resistance ▶ Can be fitted with minimal disruption to door 	Jambs & head	Acoustic Smoke BS EN ISO 10140-2:2010 BS 476-31.1:1983 BS EN 1634-3:2004 Durability CERTIFIRE 100,000 cycles CF5179 UL R27972
2 LP1504DS	Combined acoustic, smoke & fire seal	<ul style="list-style-type: none"> ▶ Low friction for ease of door operation ▶ Offers continuous smoke seal 	Jambs & head	Acoustic Smoke BS EN ISO 10140-2:2010 BS 476-31.1:1983 BS 9999 Fire BS 476-20/22:1987 BS EN 1634-1:2014 Durability CERTIFIRE 100,000 cycles CF341, CF330
3 FF1	A bead applied intumescent gasket for 30 minutes fire resistance	<ul style="list-style-type: none"> ▶ Easy to install ▶ Design enables tolerances between door, bead & glass thicknesses to be accommodated 	Glazing seal	Fire CERTIFIRE BS 476-20/22:1987 CF327 Glass type Pyroguard 1230 x 230 x 7.2mm
4 LAS8001 si	Drop seal	<ul style="list-style-type: none"> ▶ Mechanism lifts the seal clear of the floor when opened ▶ Self-levelling works on uneven floors 	Threshold	Acoustic Smoke BS EN ISO 10140-2:2010 BS 476-31.1:1983 BS EN 1634-3:2004 BS 9999 Fire BS 476-20/22:1987 BS EN 1634-1:2014 Durability CERTIFIRE 100,000 cycles CF5179 UL R27972
5 LP2004 (x2)	Fire seals	<ul style="list-style-type: none"> ▶ Easy to fit 	Back of frame	Fire CERTIFIRE BS 476-20/22:1987 CF341, CF330

31dB

LAS1212, LP1504, LP1004 x 2, LAS1011 x 2,
LAS4012 & LAS8002 si

DOUBLE LEAF | SINGLE SWING | 44MM |
UNGLAZED | PARTICLE BOARD

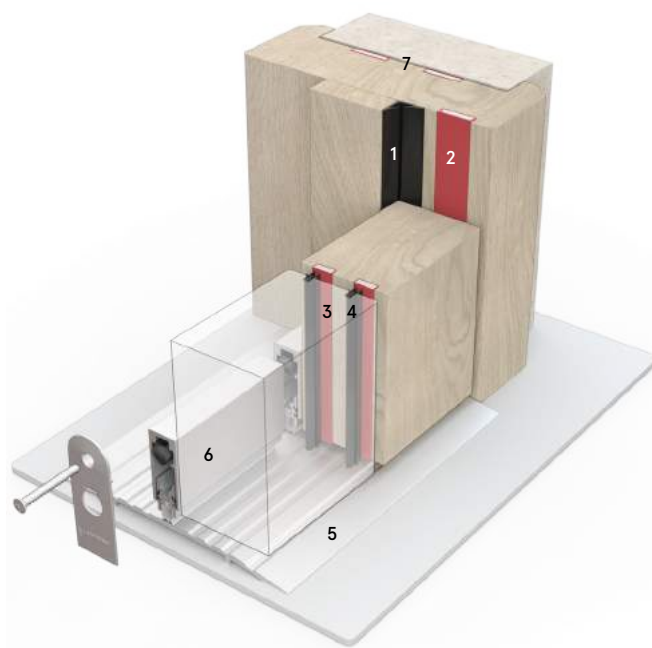

FIRE RATED DOORS - 30 MINUTES

Product	Description	Key Features	Location	Performance
1 LAS1212 Batwing®	Acoustic & smoke perimeter seal	<ul style="list-style-type: none"> ▶ Curved fin shape minimises open/closing resistance ▶ Can be fitted with minimal disruption to door 	Jambs & head	Acoustic Smoke BS EN ISO 10140-2:2010 BS 476-31.1:1983 BS EN 1634-3:2004 Durability CERTIFIRE 100,000 cycles CF5179 UL R27972
2 LP1504	Fire seal	<ul style="list-style-type: none"> ▶ Easy to fit 	Jambs & head	Fire CERTIFIRE BS 476-20/22:1987 CF341, CF330
3 LP1004 (x2)	Fire seal	<ul style="list-style-type: none"> ▶ Easy to fit 	Meeting stiles	As above
4 LAS1011 Firtree® (x2)	Acoustic & smoke seal	<ul style="list-style-type: none"> ▶ Flexible durable 4mm fins ▶ Easy to fit 	Meeting stiles	Acoustic Smoke BS EN ISO 10140-2:2010 BS EN 1634-3:2004 BS 476: Pt.31.1:1983 Durability CERTIFIRE 100,000 cycles CF5179 UL R27972
5 LAS4012	Low profile threshold plate	<ul style="list-style-type: none"> ▶ Only 6mm high ideal for wheeled traffic ▶ Works with any threshold seal 	Threshold	UL R27972
6 LAS8002 si	Drop seal	<ul style="list-style-type: none"> ▶ Mechanism lifts the seal clear of the floor when opened ▶ Self-levelling works on uneven floors 	Threshold	Acoustic Smoke BS EN ISO 10140-2:2010 BS 476-31.1:1983 BS EN 1634-3:2004 BS 9999 Fire BS 476-20/22:1987 BS EN 1634-1:2014 Durability CERTIFIRE 100,000 cycles CF5179 UL R27972
7 LP2004 (x2)	Fire seals	<ul style="list-style-type: none"> ▶ Easy to fit 	Back of frame	Fire CERTIFIRE BS 476-20/22:1987 CF341, CF330

32dB

LAS1212, LP1504DS, LP1004DS, LP1004, LAS4011 & LAS8001 si

DOUBLE LEAF | SINGLE SWING | 44MM |
UNGLAZED | PARTICLE BOARD



Product	Description	Key Features	Location	Performance
1 LAS1212 Batwing®	Acoustic & smoke perimeter seal	<ul style="list-style-type: none"> ▶ Curved fin shape minimises open/closing resistance ▶ Can be fitted with minimal disruption to door 	Jambs & head	Acoustic Smoke BS EN ISO 10140-2:2010 BS 476-31.1:1983 BS EN 1634-3:2004 Durability CERTIFIRE 100,000 cycles CF5179 UL R27972
2 LP1504DS, LP1004DS	Combined acoustic, smoke & fire seal	<ul style="list-style-type: none"> ▶ Exceptional low friction for ease of door operation ▶ Offers continuous smoke seal 	Jambs & head, meeting stiles (LP1004DS)	Acoustic Smoke BS EN ISO 10140-2:2010 BS 476-31.1:1983 BS 9999 Fire BS 476-20/22:1987 BS EN 1634-1:2014 Durability CERTIFIRE 100,000 cycles CF341, CF330
3 LP1004	Fire seal	<ul style="list-style-type: none"> ▶ Easy to fit 	Meeting stiles	Fire CERTIFIRE BS 476-20/22:1987 CF341, CF330
4 LAS4011	Low profile threshold plate	<ul style="list-style-type: none"> ▶ Only 6mm high ideal for wheeled traffic ▶ Works with any threshold seal 	Threshold	UL R27972
5 LAS8001 si with cladding kit	Drop seal	<ul style="list-style-type: none"> ▶ Mechanism lifts the seal clear of the floor when opened ▶ Self-levelling works on uneven floors 	Threshold	Acoustic Smoke BS EN ISO 10140-2:2010 BS 476-31.1:1983 BS EN 1634-3:2004 BS 9999 Fire BS 476-20/22:1987 BS EN 1634-1:2014 Durability CERTIFIRE 100,000 cycles CF5179 UL R27972
6 LP2004 (x2)	Fire seals	<ul style="list-style-type: none"> ▶ Easy to fit 	Back of frame	Fire CERTIFIRE BS 476-20/22:1987 CF341, CF330



33dB

LP1504 Finesse™, LP1504 & LAS8001 si with cladding kit

SINGLE LEAF | SINGLE SWING | 54MM |
UNGLAZED | LAMINATED SOFTWOOD



FIRE RATED DOORS - 60 MINUTES

Product	Description	Key Features	Location	Performance
1 LP1504 Finesse™	Combined acoustic, smoke & fire seal	<ul style="list-style-type: none"> ▶ Low friction for ease of door operation ▶ Offers continuous smoke seal 	Jambs & head	Acoustic Smoke BS EN ISO 10140-2:2010 BS 476-31.1:1983 BS 9999 Fire BS 476-20/22:1987 BS EN 1634-1:2014 Durability 100,000 cycles CERTIFIRE CF341, CF330
2 LP1504	Fire seal	<ul style="list-style-type: none"> ▶ Easy to fit 	Jambs & head	Fire CERTIFIRE BS 476-20/22:1987 CF341, CF330
3 LAS8001 si & cladding kit	Drop seal	<ul style="list-style-type: none"> ▶ Mechanism lifts the seal clear of the floor when opened ▶ Self-levelling works on uneven floors 	Threshold	Acoustic Smoke BS EN ISO 10140-2:2010 BS 476-31.1:1983 BS EN 1634-3:2004 BS 9999 Fire BS 476-20/22:1987 BS EN 1634-1:2014 Durability 100,000 cycles CERTIFIRE CF5179 UL R27972
4 LP2004 (X2)	Fire seals	<ul style="list-style-type: none"> ▶ Easy to fit 	Back of frame	Fire CERTIFIRE BS 476-20/22:1987 CF341, CF330

35dB

LP1504DS x 2 & LAS8001 si with cladding kit

SINGLE LEAF | SINGLE SWING | 54MM |
UNGLAZED | PARTICLE BOARD



Product	Description	Key Features	Location	Performance
1 LP1504DS (x2)	Combined acoustic, smoke & fire seal	<ul style="list-style-type: none"> ▶ Low friction for ease of door operation ▶ Offers continuous smoke seal 	Jambs & head	Acoustic Smoke BS EN ISO 10140-2:2010 BS 476-31.1:1983 BS 9999 Fire BS 476-20/22:1987 BS EN 1634-1:2014 Durability 100,000 cycles CERTIFIRE CF341, CF330
2 LAS8001 si & cladding kit	Drop seal	<ul style="list-style-type: none"> ▶ Mechanism lifts the seal clear of the floor when opened ▶ Self-levelling works on uneven floors 	Threshold	Acoustic Smoke BS EN ISO 10140-2:2010 BS 476-31.1:1983 BS EN 1634-3:2004 BS 9999 Fire BS 476-20/22:1987 BS EN 1634-1:2014 Durability 100,000 cycles CERTIFIRE CF5179 UL R27972
3 LP2004 (x2)	Fire seals	<ul style="list-style-type: none"> ▶ Easy to fit 	Back of frame	Fire CERTIFIRE BS 476-20/22:1987 CF341, CF330



35dB

LAS1212, LP1504, LP1504DS & LAS8001 si with cladding kit

SINGLE LEAF | SINGLE SWING | 54MM |
UNGLAZED | LAMINATED SOFTWOOD



FIRE RATED DOORS - 60 MINUTES

Product	Description	Key Features	Location	Performance
1 LAS1212* Batwing®	Acoustic & smoke perimeter seal	<ul style="list-style-type: none"> ▶ Curved fin shape minimises open/closing resistance ▶ Can be fitted with minimal disruption to door 	Jambs & head	Acoustic Smoke BS EN ISO 10140-2:2010 BS 476-31.1:1983 BS EN 1634-3:2004 Durability CERTIFIRE 100,000 cycles CF5179 UL R27972
2 LP1504*	Fire seal	<ul style="list-style-type: none"> ▶ Easy to fit 	Jambs & head	Fire CERTIFIRE BS 476-20/22:1987 CF341, CF330
3 LP1504DS	Combined acoustic, smoke & fire seal	<ul style="list-style-type: none"> ▶ Low friction for ease of door operation ▶ Offers continuous smoke seal 	Jambs & head	Acoustic Smoke BS EN ISO 10140-2:2010 BS 476-31.1:1983 BS 9999 Fire BS 476-20/22:1987 BS EN 1634-1:2014 Durability CERTIFIRE 100,000 cycles CF341, CF330
4 LAS8001 si with cladding kit	Drop seal	<ul style="list-style-type: none"> ▶ Mechanism lifts the seal clear of the floor when opened ▶ Self-levelling works on uneven floors 	Threshold	Acoustic Smoke BS EN ISO 10140-2:2010 BS 476-31.1:1983 BS EN 1634-3:2004 BS 9999 Fire BS 476-20/22:1987 BS EN 1634-1:2014 Durability CERTIFIRE 100,000 cycles CF5179 UL R27972
5 LP2004 (x2)	Fire seals	<ul style="list-style-type: none"> ▶ Easy to fit 	Back of frame	Fire CERTIFIRE BS 476-20/22:1987 CF341, CF330

*Fire seal with Batwing® to comply with BS 9999

35dB

LP1504DS, LP1504, System-36/15 PLUS & LAS8001 si with cladding kit

SINGLE LEAF | SINGLE SWING | 54MM |
15MM PYROSTOP | PARTICLE BOARD

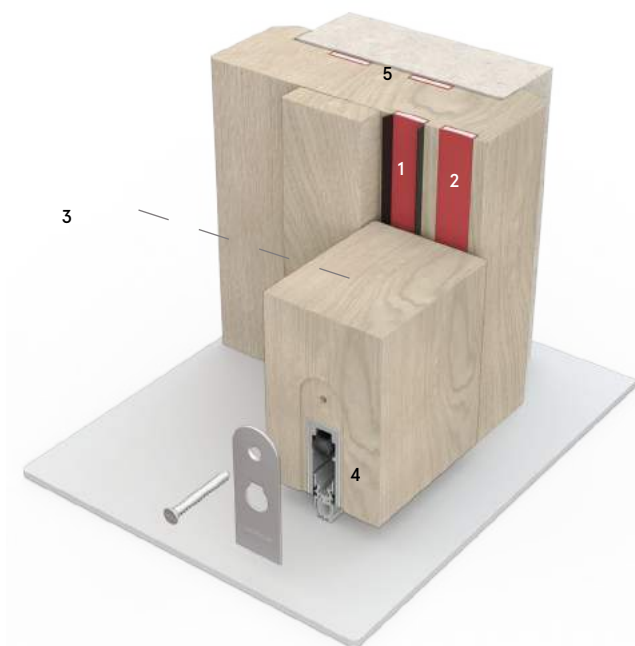

Product	Description	Key Features	Location	Performance
1 LP1504DS	Combined acoustic, smoke & fire seal	<ul style="list-style-type: none"> ▶ Low friction for ease of door operation ▶ Offers continuous smoke seal 	Jambs & head	Acoustic Smoke BS EN ISO 10140-2:2010 BS 476-31.1:1983 BS 9999 Fire BS 476-20/22:1987 BS EN 1634-1:2014 Durability CERTIFIRE 100,000 cycles CF341, CF330
2 LP1504	Fire seal	<ul style="list-style-type: none"> ▶ Easy to fit 	Jambs & head	Fire CERTIFIRE BS 476-20/22:1987 CF341, CF330
3 System 36/15 PLUS	Flexible U-shaped intumescent gasket for 60 minute fire resistant doors and screens	<ul style="list-style-type: none"> ▶ Suitable for use with range of standard fixing beads ▶ Flexible enough to be fitted to curved corners & circular vision panels 	Glazing seal	Fire Smoke CERTIFIRE Glass type BS 476-20/22:1987 BS EN 1634-1:2008 CF5060 Pyrostop 1580 x 300 x 15mm
4 LAS8001 si with cladding kit	Drop seal	<ul style="list-style-type: none"> ▶ Mechanism lifts the seal clear of the floor when opened ▶ Self-levelling works on uneven floors 	Threshold	Acoustic Smoke BS EN ISO 10140-2:2010 BS 476-31.1:1983 BS EN 1634-3:2004 BS 9999 Fire BS 476-20/22:1987 BS EN 1634-1:2014 Durability CERTIFIRE 100,000 cycles CF5179 UL R27972
5 LP2004 (x2)	Fire seals	<ul style="list-style-type: none"> ▶ Easy to fit 	Back of frame	Fire CERTIFIRE BS 476-20/22:1987 CF341, CF330

FIRE RATED DOORS - 60 MINUTES

32dB

LAS1212, LP1504, LP1504DS x 3,
LAS9010 with cladding kit, LAS4014 si,
LAS8001 si with cladding kit & RF1™

DOUBLE LEAF | SINGLE SWING | 54MM |
GLAZED | PARTICLE BOARD

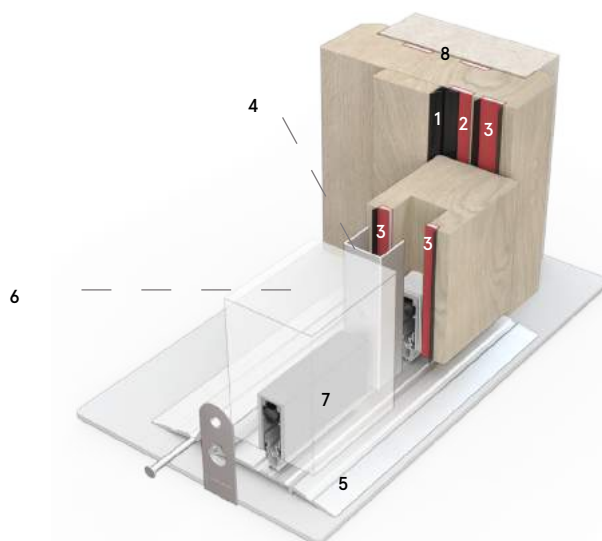

FIRE RATED DOORS - 60 MINUTES

Product	Description	Key Features	Location	Performance
1 LAS1212* Batwing®	Acoustic & smoke perimeter seal	<ul style="list-style-type: none"> ▶ Curved fin shape minimises open/closing resistance ▶ Can be fitted with minimal disruption to door 	Jambs & head	Acoustic Smoke BS EN ISO 10140-2:2010 BS 476-31.1:1983 BS EN 1634-3:2004 Durability CERTIFIRE 100,000 cycles CF5179 UL R27972
2 LP1504*	Fire seal	<ul style="list-style-type: none"> ▶ Easy to fit 	Jambs & head	Fire CERTIFIRE BS 476-20/22:1987 CF341, CF330
3 LP1504DS (x3)	Combined acoustic, smoke & fire seal	<ul style="list-style-type: none"> ▶ Low friction for ease of door operation ▶ Offers continuous smoke seal 	Jambs & head, meeting stiles (LP1504DS x2)	Acoustic Smoke BS EN ISO 10140-2:2010 BS 476-31.1:1983 BS 9999 Fire BS 476-20/22:1987 BS EN 1634-1:2014 Durability CERTIFIRE 100,000 cycles CF341, CF330
4 LAS9010 with cladding kit	Flush bolt	<ul style="list-style-type: none"> ▶ Seamlessly integrates with LAS8001 si drop seal ▶ Together they provide the ultimate system combining security, with acoustic, smoke and energy containment at the bottom of the door 	Meeting stiles	Acoustic Maintains acoustic performance of drop seal 41dB (BS EN ISO 10140-1:2010+A2:2014, Annex J) Fire BS 476-20/22:1987 BS EN 1634-1:2014 Durability 50,000 cycles Classified to BS EN 12051:2000
5 LAS4014 si	Threshold plate	<ul style="list-style-type: none"> ▶ Silicone gasket enhances acoustic containment 	Threshold	Acoustic UL R27972 BS EN ISO 10140-2:2010
6 RF1™ with intumescent liner	Bead applied intumescent gaskets for 60 minutes fire resistance	<ul style="list-style-type: none"> ▶ Easy to install ▶ Design enables tolerances between door, bead & glass thicknesses to be accommodated 	Glazing seal	Fire CERTIFIRE Glass type BS 476-20/22:1987 CF5033 Pyrogard 1500 x 300 x 11mm
7 LAS8001 si with cladding kit	Drop seal	<ul style="list-style-type: none"> ▶ Mechanism lifts the seal clear of the floor when opened ▶ Self-levelling works on uneven floors 	Threshold	Acoustic Smoke BS EN ISO 10140-2:2010 BS 476-31.1:1983 BS EN 1634-3:2004 BS 9999 Fire BS 476-20/22:1987 BS EN 1634-1:2014 Durability CERTIFIRE 100,000 cycles CF5179 UL R27972
8 LP2004 (x2)	Fire seals	<ul style="list-style-type: none"> ▶ Easy to fit 	Back of frame	Fire CERTIFIRE BS 476-20/22:1987 CF341, CF330

*Fire seal with Batwing® to comply with BS 9999

35dB

LAS1212, LP1504, LP1504DS x 3,
LAS1016 x 2 & AAS4508 si

DOUBLE LEAF | SINGLE SWING | 54MM |
UNGLAZED | LAMINATED SOFTWOOD



Product	Description	Key Features	Location	Performance
1 LAS1212* Batwing®	Acoustic & smoke perimeter seal	<ul style="list-style-type: none"> ▶ Curved fin shape minimises open/closing resistance ▶ Fitted with minimal disruption to door 	Jambs & head	Acoustic BS EN ISO 10140-2:2010 Smoke BS 476-31.1:1983 Durability 100,000 cycles CERTIFIRE CF5179 UL R27972
2 LP1504*	Fire seal	<ul style="list-style-type: none"> ▶ Easy to fit 	Jambs & head	Fire BS 476-20/22:1987 CERTIFIRE CF341, CF330
3 LP1504DS (x3)	Combined acoustic, smoke & fire seal	<ul style="list-style-type: none"> ▶ Low friction for ease of door operation ▶ Offers continuous smoke seal 	Jambs & head, meeting stiles (LP1504DS x2)	Acoustic BS EN ISO 10140-2:2010 Smoke BS 476-31.1:1983 BS 9999 Fire BS 476-20/22:1987 BS EN 1634-1:2014 Durability 100,000 cycles CERTIFIRE CF341, CF330
4 LAS1016 Firtree® (x2)	Acoustic & smoke seal	<ul style="list-style-type: none"> ▶ Flexible durable fins ▶ Easy to fit 	Threshold	Acoustic BS EN ISO 10140-2:2010 Smoke BS EN 1634-3:2004 BS 476-31.1:1983 Durability 100,000 cycles
5 AAS4508 si	A stepped threshold plate	<ul style="list-style-type: none"> ▶ Silicone gasket enhances acoustic containment ▶ Acoustic bedding pads reduce vibration & provide cushioning on uneven surfaces ▶ Reversible tread strips enhance grip 	Threshold	Acoustic BS EN ISO 10140-2:2010 UL R27972
6 LP2004 (x2)	Fire seals	<ul style="list-style-type: none"> ▶ Easy to fit 	Back of frame	Fire BS 476-20/22:1987 CERTIFIRE CF341, CF330

*Fire seal with Batwing® to comply with BS 9999

ARCHITECTURAL SEALS

The Lorient Architectural Seals range incorporates a variety of complementary door sealing systems including perimeter seals, drop seals, threshold plates, door bottom seals plus much more.

DROP SEALS

A range of drop seals that fit to the bottom of a door and drop down automatically when the door closes to form a firm seal. Options include face-fixed, semi or fully mortised installation.

PERIMETER SEALS

A comprehensive range of slimline perimeter seals for installation around the head, jambs + meeting stiles of doors.

THRESHOLD PLATES + RAMPS

Threshold plates provide a firm and effective sealing surface for threshold seals to rest against, while also covering the join between different flooring materials.

DOOR BOTTOM SEALS

A range of versatile + hardwearing door bottom seals, that seal the gap between the bottom of the door and the floor.

BRUSH SEALS

A series of hard-wearing sweep action brush seals suitable for numerous installations and door types; including single + double swing, revolving, sliding, up and over and roller shutter doors.

MAGNETIC SEALS

Magnetic seals for use on both steel and timber doors. These seals provide a tight seal for door jambs and may also be used as a stop.

MEETING STILE SEAL

A robust seal designed for use on plain or rebated meeting stiles.

SPECIALITY SEALS

A range of speciality seals that features a finger guards, drip guards; and an innovative, slimline flush bolt that seamlessly integrates with our most popular drop seal - LAS8001 si.

STAINLESS STEEL RANGE

This range incorporates threshold plates, perimeter seals and automatic threshold seals manufactured in hard-wearing stainless steel.

COMPRESSION SEALS

A variety of durable, flexible + lightweight seals that are easy to fit to the perimeter of timber doors + window frames.

GLASS DOOR SEALS

A choice of highly durable glass door seals for both the perimeter + bottom of the door.

COLOUR RANGE

Our wide range of colours provides inspiration for all types of buildings; from luxurious and contemporary hotels, to bright and bold nurseries and schools - there's a perfect colour or finish available to suit every project.

STANDARD COLOURS

Please note that the DS, TS, AS and SS profiles are supplied with black fins or brushes as standard. The Finesse™ profile is supplied with clear fins as standard.



White



Black



Dark Brown



Light Brown

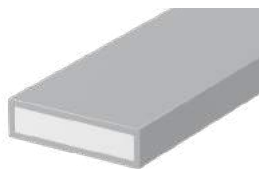

Grey

NON-STANDARD

Special order; additional charges, minimum order quantities and extended lead times apply.



Red



Silver



Cream

Note: The limitations of the printing process mean the colours shown here may not be exactly the same as the seals supplied. We can supply free mini samples to assist colour matching.

WOODGRAIN FINISHES

Lorient's woodgrain collection authentically replicates the beauty and ageless appeal of real wood. Naturally understated but strikingly elegant the woodgrain finishes harmonise with commonly specified timbers.

WOODGRAIN FINISHES

Many seals are available with a woodgrain finish. These finishes are achieved by laminating special polyester films directly onto the PVC casing of the seal - there's a perfect finish available to suit every project.

Special order; minimum order quantities and extended lead times apply.



Limed Oak



American Sycamore



Ash



Beech



American White Oak



Medium Oak



American Cherry



Sapele



Teak

Note: The limitations of the printing process mean the finishes shown here may not be exactly the same as the seals supplied. We can supply free mini samples to assist colour matching. It should also be remembered that timber darkens with age and can change colour significantly when polishes and other clear finishes are applied.

LIGHT REFLECTIVE VALUE

Light Reflectance Values (LRV), are a measure of the percentage of visible and usable light that is reflected from a surface when illuminated by a light source.

The values below have been determined with reference to the CIE LAB colour measurement method. The L co-ordinate represents lightness and extends from 0 (Black) to 100 (White) and has been used as a measure of light reflectance value.



White

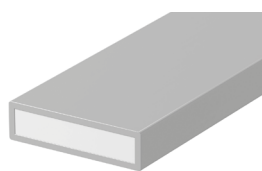

Grey



Silver

	CIE Y VALUE	L*	A*	B*
BLACK	4.76	27.39	-0.03	-0.9
DARK BROWN	8.61	35.15	35.15	35.15
RED	15.61	46.49	48.27	24.89
LIGHT BROWN	17.39	48.78	8.71	17.28
GREY	22.63	54.73	-0.73	-0.16
SILVER	27.49	59.28	-1.07	-2.3
CREAM	57.65	80.59	1.91	25.13
WHITE	86.03	94.24	-1.46	1.81

COLOUR INFORMATION

	COLOURS	WOODGRAIN	NOTES
FINESSE™	✓	✓	Clear fins as standard.
DS	✓	-	Black fins as standard.
TS SEAL	✓	✓	Black fins as standard.
AS SEAL	✓	-	Black fins as standard.
SS SEAL	✓	✓	Black brush as standard.
FIRE SEAL	✓	✓	-

BESPOKE FINISHES

We are also able to offer many special finishes and a precise colour matching service. Additional charges, minimum order quantities and extended lead times apply.

ACOUSTIC TESTING

The only way to determine the performance of a particular doorset design is to test that product, installed into a structure in a manner that replicates precisely the methods intended for use.



Lorient Acoustic Transmission Suite

How we test our products

We test the acoustic properties of each doorset and sealing system combination in our acoustic transmission suite in accordance with BS EN ISO 10140.

The test involves installing the assembly (door/window etc) within a dividing wall between a sound source room and a receiving room. Sound waves across the full frequency range are produced in the source room. The receiving room measures the sound pressure level. The difference between the sound pressure levels recorded in each room is determined as the Sound Reduction in index (R).

The Sound Reduction Index is an expression of the laboratory sound transmission performance of a particular element or construction. It is a function of the mass, thickness, sealing method and overall area of sample.

A series of tests will usually include measurement of a 'fully caulked' doorset. This is a test carried out using high density sealing (caulking) material to fill all gaps and provides a useful reference for the efficiency of a particular sealing system.

Lorient test programmes are conducted with a range of common door cores, tested in real door scenarios, for example with an accepted industry gap size of 3-4mm. All Lorient sealing systems are acoustically tested in everyday operational mode and many are tested with long vision panels to meet the requirements of Approved Document M.

Rest assured that all information in this brochure has been derived from full size door assemblies.

A third party certificated timber doorset is the best guarantee that all elements – ironmongery, fire and smoke seals and glazing – are fully tested to the relevant standards.

For specialist doors and door blanks, it is essential to consult the manufacturer to determine which seals have been tested. Our Acoustic Search tool on our website provides quick and easy access to a wide range of tested acoustic sealing systems on a variety of popular door constructions and configurations.

FIRE TESTING

Fire and smoke protection measures are essential, life-saving precautions in a building. What's more, they protect the property from the devastating consequences of the fire itself, and the damaging effects of hot and cold smoke.

Fire and smoke protection products must be tested to prove their performance. Separate tests are required for fire and smoke.

Meeting the requirements

Fire resistance can be determined through destructive fire testing designed to replicate the product's intended end-use. Test evidence will be generated, demonstrating fire resistance performance to the required period of time (e.g. 30, 60, 90, 120 minutes).

The performance of a doorset must be considered as a complete unit i.e. the door leaf/leaves, frames, fire and smoke seals, vision panels and associated component parts, including door hardware.

Our acoustic, smoke and fire seals have been tested in accordance with British and European standards on a complete range of fire door configurations; single leaf, double leaf, single acting, double acting, latched and unlatched. This means that the door assembly will need to have several test reports:

- ▶ Fire resistance under the conditions of BS 476-22:1987; BS EN 1634-1:2014
- ▶ Smoke control under the conditions of BS 476-31.1:1983; BS EN 1634-3:2004
- ▶ Acoustic performance under the conditions of BS EN ISO 10140-2:2010, rated in accordance with BS EN ISO 717-1:2020.
- ▶ Fire safety in the design, management and use of buildings. Code of practice. BS 9999:2017.

The requirements for fire and smoke containment with regard to 'means of escape' are contained in the following documents; Approved Document B (England), Approved Document B (Wales),

▲ Loriet Indicative Furnace

Technical Booklet E (N. Ireland), Technical Handbook Section 2 (Scotland).

These documents specify that practically all internal fire resistant door assemblies are also required to prevent the passage of cold smoke.

Please bear in mind that performance in relation to cold smoke needs to be considered separately from performance in relation to fire and hot smoke, and a separate test report is required.

Third Party Certification

Loriet acoustic, smoke and fire seals are CERTIFIRE approved for use on timber-based fire door assemblies. We also have British Board of Agrément, IFC and UL certification on a range of our seals.

If you require any further details, please contact our Technical Team via technical@lorientuk.com or call +44 (0) 1626 834252.



TESTING + TECHNICAL SERVICES

We've built our reputation on the quality and dependability of our products, and our investment in R&D has played a pivotal role in keeping our products at the forefront of our industry. Our dedicated Testing and Technical Services division has established itself as an important facility for manufacturers and designers of doors, windows, glazing systems and hardware, to name just a few.

TESTING SERVICES

Whether you're investigating new materials, or developing new or existing products, right through to durability testing and benchmarking performance – our team of experts will support you throughout the process. We are able to offer:

- ▶ Fire testing (indicative)
- ▶ ATG commissioning and maintenance for fire & smoke resisting air transfer grilles
- ▶ Mechanical cycling
- ▶ Environmental chamber analysis
- ▶ Attendance at external fire tests
- ▶ Consultancy services.

▲
Lorient Indicative Furnace

ADDITIONAL INFORMATION

TECHNICAL REFERENCES

Lorient is quality assured under the disciplines of BS EN ISO 9001:2015.

Accreditation to this standard is an assurance that we conduct our business to the complete satisfaction of our customers with regard to design solutions, manufacturing consistency and management procedures.

As a result, this internationally recognised standard for quality management generates customer confidence. Regular audits of our company procedures are undertaken by qualified BSI staff to ensure ongoing compliance with all aspects of the standard.



BS EN ISO 9001:2015 Certificate No. Q6104

Lorient has attained the BS EN ISO 14001:2015 accreditation for environmental management. This internationally recognised standard shows that we have demonstrated our commitment to responsible environmental behaviour, including prevention of pollution, control and reduction of waste, and ongoing monitoring and improvement of our environmental performance. Achieving ISO 14001 is just one part of our ongoing commitment to operate in a sustainable way.



BS EN ISO 14001:2015 Certificate No. EMS 541906

FITTING INSTRUCTIONS

Comprehensive fitting instructions are available to download from our website www.lorientuk.com

MAINTENANCE

Periodic inspection/cleaning is recommended for all types of seals. The appearance and performance of brush seals will benefit from a wipe with a damp cloth at least once a year. Worn or damaged seals should be replaced without delay.

Further guidance is contained in the relevant sections of BS 8214:2016 "Code of practice for fire door assemblies".

HANDLING + STORAGE

No special precautions are required when handling our fire seals but they should always be treated with care and not bent or twisted. Safety data sheets are available on request. These products do not fall within the scope of COSHH regulations.

Our intumescent seals should be stored flat in a clean, dry, dust-free area away from heat and at a storage temperature of between 5°C and 40°C.

GUARANTEE OF ORIGIN

Each production batch of Lorient seals is identified unobtrusively on the edge of the profile with the Lorient name, product code reference, batch no., date of manufacture and third party accreditation. This ensures the product and details of its production can be traced should the need arise.

Unidentifiable substitute products should never be accepted.

MADE IN BRITAIN

We are proud to have been granted the prestigious Made in Britain marque for our products, designed and manufactured at our main facility in South West of the UK.



INTELLECTUAL PROPERTY

© 2023 ASSA ABLOY Ltd T/A Lorient. Lorient is a registered trade mark of ASSA ABLOY LIMITED in England.

This brochure is protected by copyright and neither the drawings nor the text may be reproduced or transmitted in any form without prior consent from Lorient. Lorient products described in this brochure are protected by patents and design registrations in Great Britain and other countries.

We are committed to continually enhancing and improving our product range. We reserve the right to change product specifications from time to time without prior notice. E&OE.

January 2023.

TRADE ASSOCIATIONS

Lorient is a member and active contributor to the following:



ACCREDITATIONS

BBA

BBA approvals provide independent assurance for the designer, specifier and end-user as to the 'fitness for purpose' of building products.

CERTIFIRE

Operated by Exova Warringtonfire, CERTIFIRE is an accredited independent product conformity scheme that requires products to meet the requirements of the tests, to add minimal resistance to opening and closing forces, to prove long term performance under a variety of service conditions, and to be permanently marked for easy identification.

IFC

IFC Certification Ltd is a UKAS approved and internationally recognised provider of third party Certification services – designed to give confidence to specifiers, users, occupiers, owners and enforcement bodies that products have been thoroughly and independently evaluated and will continue to be manufactured to the same specification as originally tested.

UL

UL is a global independent safety science company that tests a diverse range of products; representative samples of a product must be tested and meet UL's stringent requirements to carry the marque. These requirements are based primarily on UL's published and nationally recognised Standards for Safety. Businesses, consumers and regulatory authorities around the world recognise the trusted rigour and technical excellence of UL certifications. Lorient is proud to have achieved the UL Mark on many of its products. These are detailed on individual pages.

CPDs

We offer three fully-accredited CPD seminars. Impartially presented by knowledgeable speakers, the seminars are structured to be technically informative, and provide practical advice.

Performance Door Design: The Basics of Sound Reduction

Effective acoustic containment helps to improve the quality of the built environment, preserving privacy as well as excluding unwanted noise. With changing regulations, it's essential to be informed of the relevant requirements and the implications for door assemblies.

Our acoustic CPD seminar covers:

- ▶ the nature of sound, examining airborne transmission of sound;
- ▶ regulatory requirements and British Standards that relate to acoustic performance;
- ▶ test procedures and interpretation of test reports;
- ▶ effective design of door assemblies for acoustic performance, including door construction and the influence of sealing systems;
- ▶ design conflicts between acoustic performance, durability and ease of operation of the door;
- ▶ independent accreditation.

The Role and Performance of Fire and Smoke-Resisting Door Assemblies

The importance of fire and smoke resisting door assemblies is illustrated by the 275 fire related fatalities and 6,192 casualties in fires (England 2021/22). Apart from the human toll, property losses each year approach £2.52 billion.

Our fire and smoke containment CPD seminar covers:

- ▶ hard facts concerning deaths, injuries and property damage caused by fire and smoke;
- ▶ regulatory requirements for fire and smoke resisting door assemblies;
- ▶ the nature and behaviour of smoke;
- ▶ effective design of door assemblies for smoke containment, including the threshold gap;
- ▶ design conflicts between fire containment, smoke containment, durability and ease of operation of the door;
- ▶ independent accreditation.

The Regulatory Reform (Fire Safety) Order 2005 and its implications for fire doors

The RRO consolidated 70 pieces of legislation; shifted responsibility for fire safety management; abolished the Fire Safety Certificate; established the Fire Risk Assessment and created major change in legal liability.

Our RRO CPD seminar covers:

- ▶ an overview of the RRO;
- ▶ product solutions;
- ▶ the dangers of fire and smoke;
- ▶ the importance of fire doors – including installation and maintenance.

Our CPD materials have been independently verified and certified by the RIBA as CPD approved. A certificate for 1 hour's CPD will be provided, which contributes to Continuing Professional Development requirements.

If you are interested in booking a seminar, please contact our Marketing department or email cpd@lorientuk.com

AIR TRANSFER GRILLE CPD WEBINAR

We're delighted to offer a CPD entitled:
The Specification + Design of Air Transfer Grilles / Dampers.

This is a fantastic addition to our growing collection of CPD seminars and explores:

- ▶ the latest test standards and building regulations;
- ▶ the major difference between intumescent air transfer grilles and dampers;
- ▶ the importance of correct specification, installation and maintenance;
- ▶ plus it offers practical solutions to fire and smoke containment over a range of applications.

All of our CPD seminars are available to view virtually, please visit www.lorientuk.com or email cpd@lorientuk.com for more information.



COMPREHENSIVE SUPPORT

As a company we have over 40 years' experience, so our experts are well equipped to listen, help and advise you on your sealing system requirements.

Technical Services

We're happy to provide specialist advice on acoustic, smoke and fire protection for refurbishment and new build projects. If you need assistance, you can call our Technical Services team.

Alternatively, we can arrange a site visit to get a clearer idea of your needs and how we can help you. We also provide copies of test reports and samples where needed; and can give guidance on how best to meet Building Regulations and Standards.

Web Support

Our website features a comprehensive range of supporting documents covering the entire range of products, including installation guides and CAD drawings. All of our brochures and products sheets are also available for download, together with copies of certification and specification texts.

Online Acoustic Search tool

Our Acoustic Search tool on our website gives you quick and easy access to a wide range of tested acoustic sealing systems on a variety of popular door constructions & configurations.

www.lorientuk.com/acousticsearch

The tool allows users to select a specific decibel rating; along with door configuration, fire door rating, doorset type etc to filter the results. The 'Acoustic Search' tool is updated frequently with Lorient's ever-expanding portfolio of test evidence. If you're looking for high performance or specialist applications – please contact us on **+44 (0) 1626 834252**, there may be some additional configurations we haven't yet published.

Customisation

If you have a particular requirement which isn't covered by the applications in this brochure, we may be able to supply an existing non-standard item, or even develop a customised solution for you. Utilising in-house expertise, bespoke products are created to your requirements; from a functional or aesthetic perspective, or both.

Lorient's dedicated Technical Services team supports and works as part of your design team, offering informed product advice and guidance on regulatory requirements and standards.



Call our Technical Services team

+44 (0) 1626 834252

www.lorientuk.com

SEALING SOLUTIONS

Detailed information about our products can be found in the following brochures:

Acoustic Sealing Systems for Door Assemblies

A comprehensive series of acoustic sealing systems for various types of door construction.

Acoustic, Smoke and Fire Seals for Door Assemblies

Our core range of high performance acoustic, smoke and fire seals.

AURA® Architectural Seals

A discerning selection of drop seals, perimeter seals, door bottom seals, threshold plates and ramps - all with strong design accents.

Lorient Architectural Seals

A variety of complementary door sealing systems including perimeter seals, drop seals, threshold plates, door bottom seals etc.

Fire Resistant Door Hardware Protection

Letterplates, door viewers, door edge protectors and intumescent kits that can safely be installed into fire rated doors without compromising the fire/smoke performance.

Fire Resistant Glazing Systems

Fire resistant glazing systems for doors, screens and partitions.

Fire and Smoke Resistant Air Transfer Grilles

A comprehensive range of intumescent air transfer grilles for doors, walls, ducts, floors and ceilings.

Copies of these brochures are available by calling **01626 834252** or download from our website **www.lorientuk.com**

FAQS

I need to buy a 30 minute fire seal – which product should I buy?

First of all, please do remember that adding a fire seal to any door doesn't automatically make it a fire door. Do make sure that you have a properly tested fire door construction.

Also, please remember that not all fire doors are the same – so there's no single answer to this question! The first thing to check is the door manufacturer's test evidence for the door you have – whatever type and size (or sizes) of seal they have tested with is what you should buy.

Where door manufacturer's test evidence isn't available, the usual recommendation is to use a 15 x 4mm seal, fitted centrally at the head and both jambs or frame of a single leaf, single acting door. (If you are in any doubt, or have a particular application you would like to discuss, please contact our Technical Services team on 01626 834252 for details).

If it's a fire and smoke door (which will be denoted FD30S), then remember that a fire seal alone will not be sufficient. You should purchase a fire seal and a separate smoke seal or a combined fire and smoke seal, such as the Lorient DS.

Can you paint over fire and smoke seals?

Over-painting of fire seals should not compromise performance in a fire situation – however, **do not paint over smoke seals** as this will certainly compromise smoke containment performance. If the smoke seal part of the seal has already been painted over, you will need to replace the smoke seal. Our seals are available in a range of colours, plus woodgrain and metallic finishes, so over-painting should not be necessary. Guidance on the painting of seals maybe found in BS 8214:2016 Timber – based fire door assemblies – Code of practice. Section 14 outlines the situations in which over painting may be applied,

an extract from which is detailed below:

"Fire door leaves are generally not required to provide a specific surface spread-of-flame barrier, and may therefore be painted or lacquered as desired, in accordance with the manufacturer's recommendations where available.

Smoke-only seals should never be over painted. For combined intumescent fire and smoke seals, the smoke element should never be over painted. For intumescent fire-only seals, there is no evidence to suggest that over painting of intumescent fire seals has any detrimental effect on the ability of the seals to perform efficiently; however, over painting should be avoided wherever possible, or if unavoidable should be limited to a maximum of five coats of conventional paint or lacquer, or a maximum of 0.5 mm, whichever is the greater.

When preparing a frame for redecorating, the use of heat or chemical strippers should be avoided if seals are incorporated. If seals are damaged by either of these processes, they should be replaced in accordance with 13.2.3. Where glazing beads are identified as having been painted with intumescent paint, specialist advice should be obtained before repainting" BS 8214:2016"

What temperature do fire seals expand?

Sodium silicate intumescent material is activated at temperatures of between 100 – 150°C, forming a rigid foam with a high level of thermal insulation; it expands to 5 – 10 times its original size.

The intumescent material is activated at a much lower temperature than that at which the smoke seal material degrades. Long before the seal has burned away, the intumescent material has expanded sealing the gaps around the door. This seals the gap between the door and the frame, so providing an effective barrier to the passage of fire and hot smoke.

For more specialised applications, we're able to utilise alternative intumescent core materials in our manufacturing process, or create bespoke sealing solutions. Please contact our Technical Services team for further information.

What is the recommended gap size at the threshold?

The gap at the bottom of a fire door should not be greater than 10mm, please refer to door manufacturers instructions for clarification.

Where fire and smoke containment is required BS 9999 states that the threshold of a fire and smoke door should not exceed **3mm** at any point; a smoke seal should be fitted at the threshold if the gap exceeds this.

What gaps are required between a fire door leaf and its frame?

The gap between the fire door and the frame is extremely important and must be suitable for the intumescent seal fitted.

The gap on a fire door should not exceed 2-4mm along the 2 long edges and head of the door leaf.

The gap on a fire and smoke door should not exceed 3mm along the 2 long edges and head of the door leaf.

I have an existing fire rated door, but I have been told that it needs to provide smoke containment too. What do you recommend?

The first product we would always recommend you consider is our Batwing® seal. With proven performance for acoustic and smoke containment, a choice of sizes for different sized door stops, and low frictional resistance for ease of door operation.

It fixes onto the doorstop with strong self-adhesive tape, it's easy to install and you won't need to remove your door to fit it.

Alternatively, another option is our range of architectural perimeter seals, which can be face-fixed to the door stop.

If you have double leaf doors, remember you will need to fit a seal at the meeting stile too.

And don't forget the threshold! It's essential to seal it for effective smoke containment. We have face-fixed options in both our door bottom seals and drop seals that can be installed without removing the door.

Do I need to fit a threshold plate?

A threshold plate is a good idea, for several reasons:

- ▶ It will help to ensure a good seal is maintained at the threshold, by giving a firm surface for a drop seal to rest against;

- ▶ It can help to prevent weather ingress when used as part of a storm-guard system (such as our LAS3008);
- ▶ If you are sealing dissimilar surfaces (eg, carpet and vinyl), the threshold plate can cover the join to prevent both wear and tripping hazards. Our threshold ramps can also easily accommodate differences in floor heights, to make access easier for all;
- ▶ If your floor surface is particularly liable to wear and tear in places below the door (eg, a high level of traffic, or over a carpet that may become compressed over time), then a threshold plate will help to prevent these uneven areas affecting the threshold seal.



Call our Technical Services team

+44 (0) 1626 834252

www.lorientuk.com

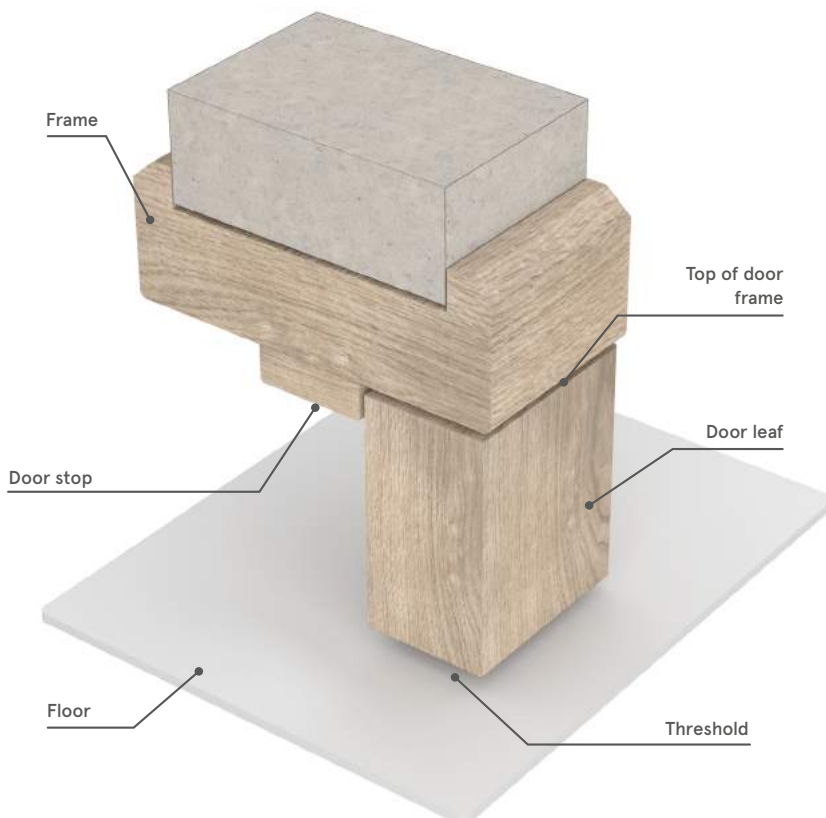

ESTETIC

E +

UK / EUROPE

T: +44 (0) 1626 834252
E: sales@lorientuk.com

AUSTRALIA

T: +61 (0) 3 8574 3888
E: customerservice.au@assaabloy.com

HONG KONG

T: +852 2260 0888
E: sales@lorienthk.com

SINGAPORE

T: +65 6880 0000
E: sales@lorient.com.sg

UAE

T: +9714 883 7206
E: sales@lorientgulf.ae

USA

T: +1 859 252 7441
E: info@lorientna.com

For further information about
Lorient products please visit:
www.lorientgroup.com