

Eclipse Self - hinge with covers

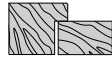

Description

Kit with one hinge with specific covers. The hinge is concealed and reversible for flush doors and 135° opening.

Application

The hinge has been tested for a capacity of 100 kg (door dimensions: 1200x2100 mm). Follow the procedure on the capacity diagram for the maximum dimensions of the possible sash.

Fastening

Mill sash and frame parts as indicated in the picture.

- Screws for frame part: Ø 5x30 mm
- Screws for sash part: Ø 5x50 mm

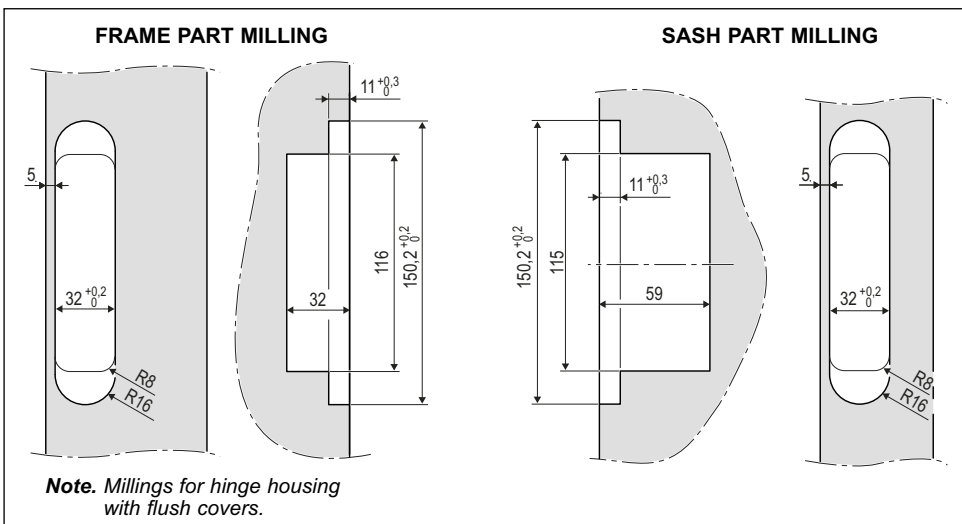
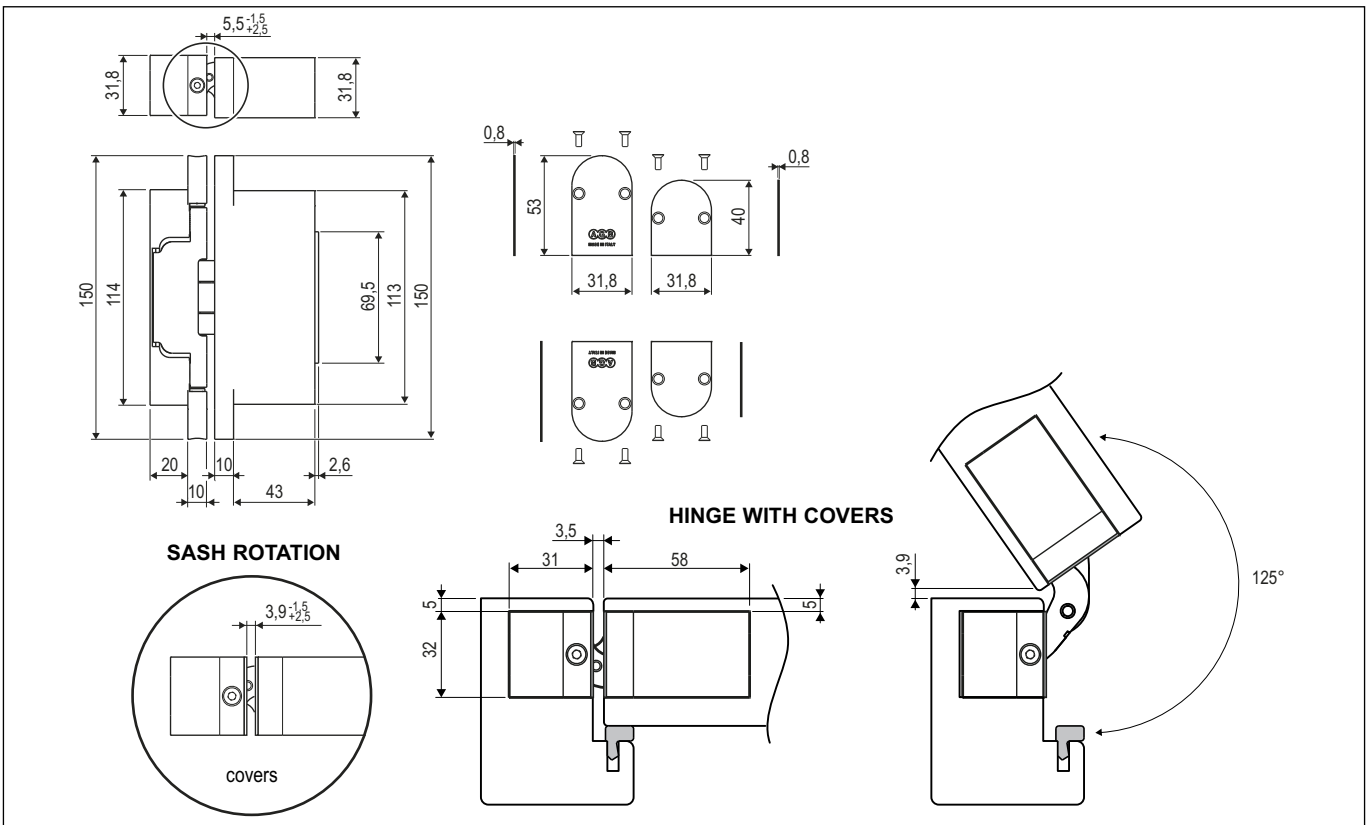

Order Specifications

Article	Description
E39001.02.XX	Hinge kit with covers

