

CYLINDERS

TECHNOLOGY & SECURITY

MADE IN ITALY

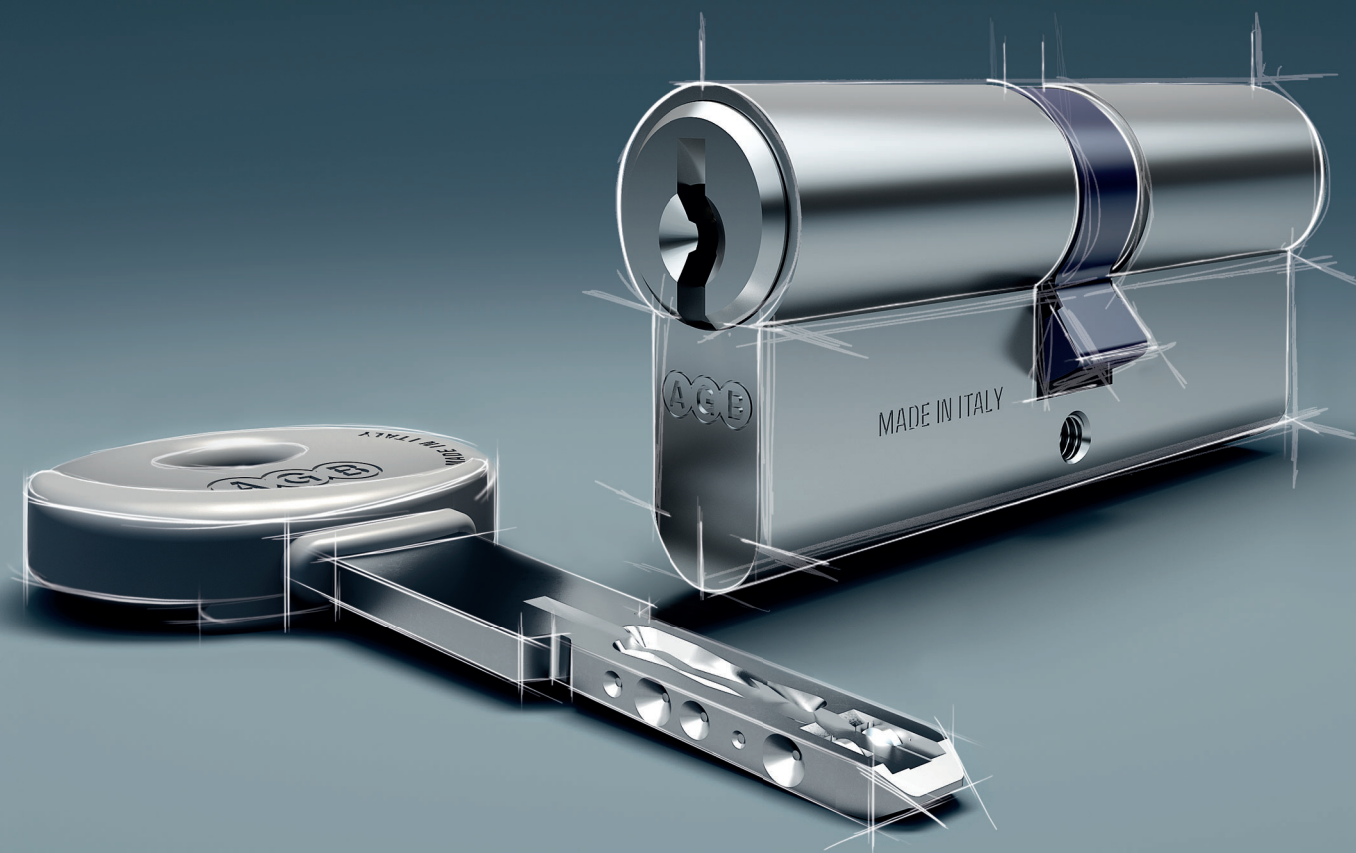

AGB[®]

Open, Close, Live

MADE IN ITALY

We are made in ITALY.

The company strategy is based on the values of the Italian culture, which is recalled on the production process and marketing choices: **Italian production**, product customisation, passion for research and creativity are the main guidelines to develop the perfect product for each customer.



ITALIAN PRODUCTION



MADE FOR YOU



CREATIVITY AND INNOVATION



PARTNERSHIP



DESIGN



CYLINDERS

AGB offers a complete range of cylinders and accessories to satisfy all the requests about security and access control, giving the perfect solution for each kind of installation.

AGB cylinders are completely made in Italy, in the dedicated plant in Pove del Grappa.

Every cylinder exceeded the strict tests required by the European regulation UNI EN 1303, guaranteeing security, quality and long-lasting durability.

 Made in Italy

 Dedicated cylinders plant

 Certified cylinders

TECHNOLOGY

INNOVATION AND QUALITY



EXTREME PRECISION

Every component of the cylinder is treated in a detailed way for a high-quality result.

A very high precision for a perfect functioning both when they open and close the door.



Maximum precision



Attention to details



High quality



AUTOMATED ASSEMBLY

The dedicated cylinders plant, the continuous investments in automation and the qualified staff guarantee the cylinders delivery in an express way all over the world.

Technologic research and direct control of every production step let us customise our cylinders, according to the customers needs.



Automated production



Express delivery



Customisation

AUTOMATIC TESTS

Our cylinders have to pass strict tests and controls in every production step.

Automatic controls are so accurate that they can simulate the movement of the hand turning the key.

Every AGB cylinder has been tested before the packaging insertion.



Strict tests in *AGBLab*



Automated control



Tested one by one

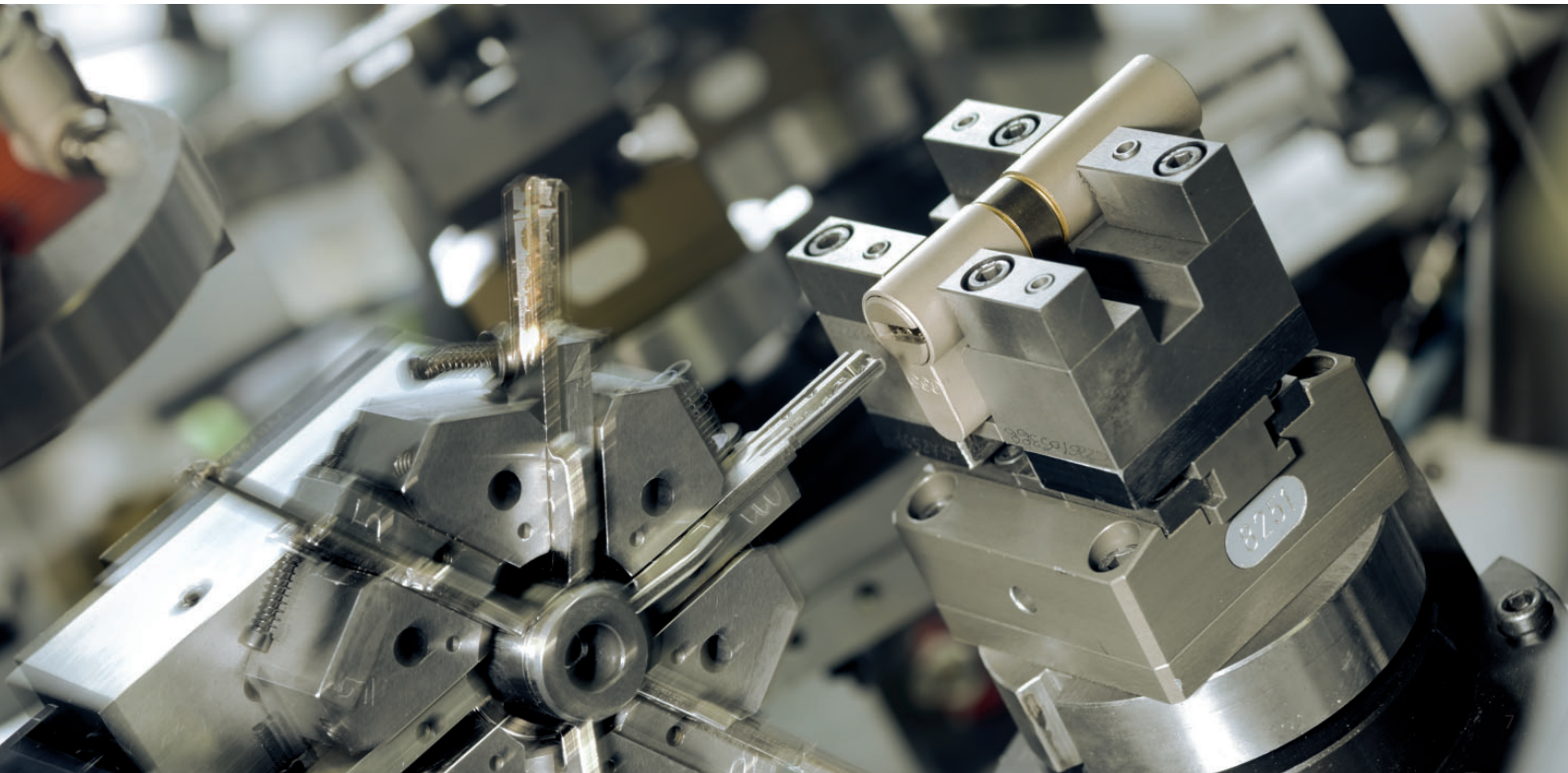

SECURITY

PROTECTION FOR YOU



AGB CYLINDERS

A warranty of security



AGB KEYS

Billions of combinations



Cylinder is the first deterrent against the break-in attempts.

AGB cylinders have been provided by the best technology to guarantee high security features to protect your home.



High bumping resistance



Hardened steel anti-drill pins



U-shaped reinforcement

The more the combinations are, the better is the warranty to have a unique key. Moreover, several combinations allow the management and the control of the accesses by means of the systems development.



Controlled duplication



Ergonomic grip



Key system management

CYLINDERS AND ACCESSORIES RANGE

Complete range of European profile security cylinders, produced according with the regulation UNI EN 9570 and tested according to the UNI EN 1303.

Cylinders SCUDO and PS offer high levels of passive and active security.

AGB cylinders include flat reversible keys in brass and silver for a better resistance against torsion.

SCUDO DCK



SCUDO 9000



5000 PS



Mod. 600



COVERS

The key can be personalised with a wide range of interchangeable covers, available in different colours.



U-TECH PS



5/6 5/6 6/6 6/6



EN 1303 Gost-R EN 1634

TENAX



The rim guard TENAX is compatible with all the cylinders, mod. SCUDO and PS. It significantly enhances the door security from the break-in attempts.

GUIDE FOR THE CYLINDER CHOICE

To identify the most suitable cylinder for your needs, we introduced an easy diagram for every available cylinder.



ANTI-BURGLAR

It indicates the resistance level to the attack with the anti-burglar methods known until now and considered by the regulation EN UNI 1303.



SYSTEMS

It indicates the number of possible combinations for every cylinder according with the regulation UNI EN 1303 and the level of difficulty in the key duplication.



DURATION

It indicates the cylinder resistance in relation to the number of opening and closing cycles in compliance with the regulation UNI EN 1303.



FINISH

It indicates the resistance level to thermal and climate stresses, as provided by the regulation UNI EN 1303. This parameter considers the corrosion resistance in order to keep the right functioning onward.

The evaluation of every cylinder is based on certified test results provided by the regulation UNI EN 1303, integrated with the results of strict tests done in the Research & Development Laboratory AGBLab.

SCUDO DCK

High security cylinder with Duplicated Controlled Key

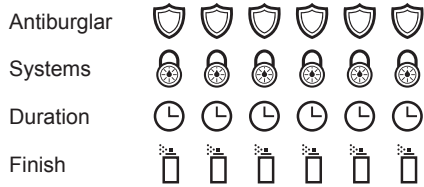

Cylinder classification - summary table on page 22

UNI EN 1303:2015 - ICIM 0039CS							
1	6	0	B	0	C	6	D

ANTI-PICKING: Pass
ANTI-BUMPING: Level 2

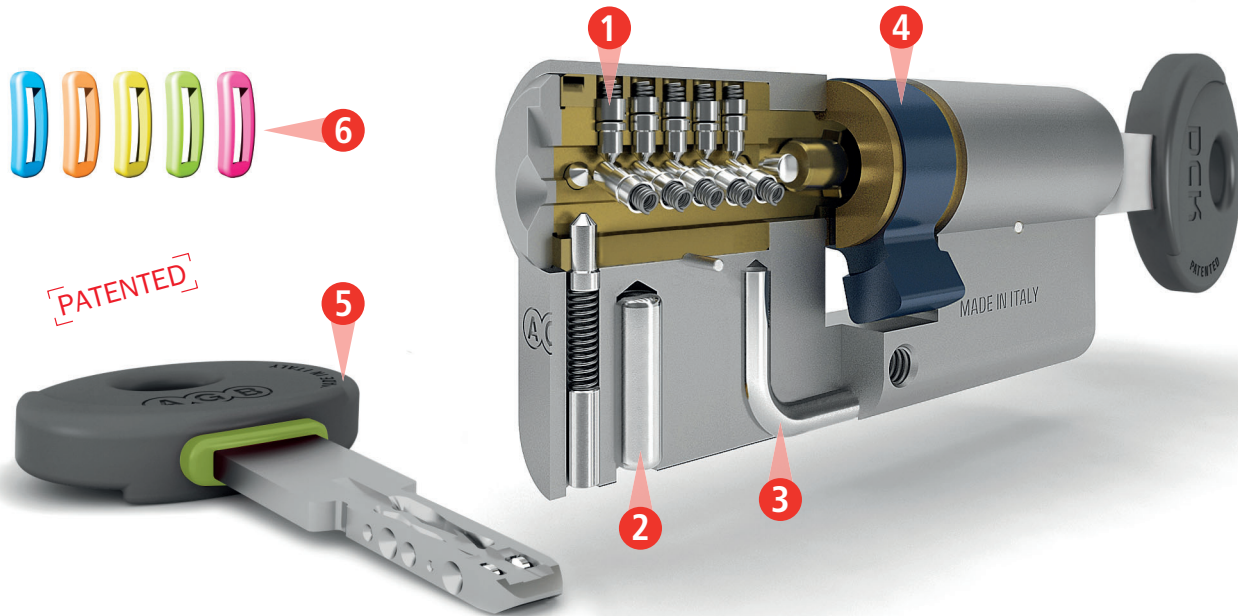

- Duplicated controlled key and protected by a PIN code.
- 15 radial and asymmetric pins in stainless steel and fixed pins to activate the key. ①
- Anti-drill pin in steel. ②
- Antiburglar insert in special steel. ③
- Anti-pull cam in sintered steel. ④
- 5 flat reversible keys. Special ergonomic grip patented by AGB. ⑤
- Customisable key with inserts of different colours (to be ordered separately). ⑥
- The double function is available (2 keys inserted at the same time).
- Suitable for fire and smoke resistant doors.

SCUDO 9000

Security cylinder with anti-intrusion element

Antiburglar



Systems



Duration



Finish



Cylinder classification - summary table on page 22

UNI EN 1303:2015 - ICIM 0039CS							
1	6	0	B	0	C	6	D

ANTI-PICKING: Pass

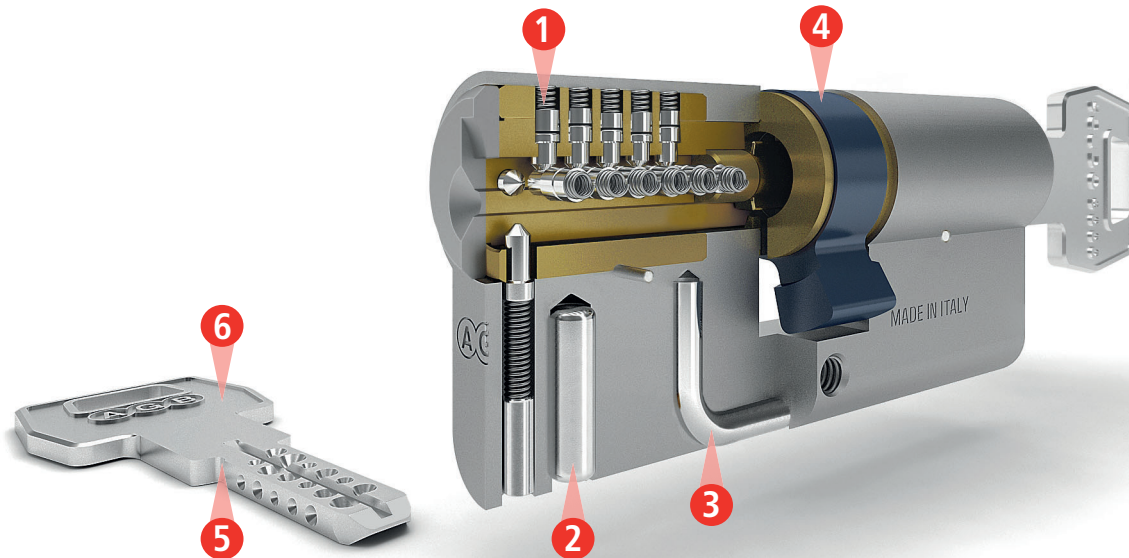

- 17 active pins and counterpins in stainless steel. ①
- Anti-drill pin in steel. ②
- Stainless steel reinforced element to prevent extraction of elements in case of damage due to break-in attempts. ③
- Anti-pull cam in sintered steel. ④
- 5 resistant flat reversible keys. ⑤
- Possibility to personalise the grip with many different coloured covers. ⑥
- Card with duplication code.
- Suitable for fire and smoke resistant doors.

Reinforced security cylinder

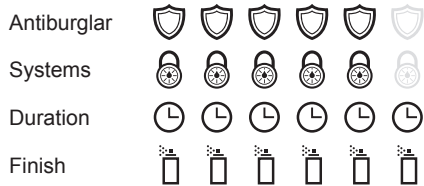

Cylinder classification - summary table on page 22

UNI EN 1303:2015 - ICIM 0039CS							
1	6	0	B	0	C	6	D

ANTI-PICKING: Pass
ANTI-BUMPING: Level 2

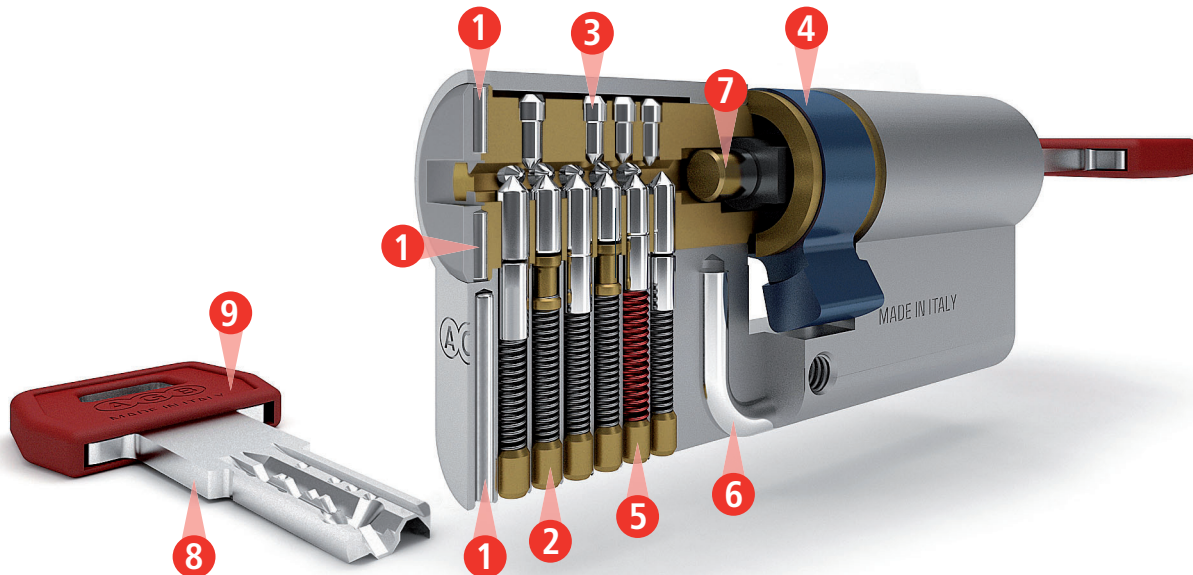

- 3 anti-drill pins in steel. ①
- 6 active pins ② and 9 passive pins ③ for a wide range of coding.
- Anti-pull cam in sintered steel. ④
- **High resistance to bumping**, certified according with ICIM 0039CS. ⑤
- Reinforced element in stainless steel: it prevents the cylinder extraction in case of break-in attempts. ⑥
- Friction coupling to open the door even when the key is inserted on the other side. ⑦
- 5 flat reversible keys with long neck that is resistant to torsion and protective rim guard. ⑧
- Possibility to personalise the grip with many different coloured covers. ⑨
- Card for the key duplication with double code (key and duplication).
- Suitable for fire and smoke resistant doors.

5000 PS

Security cylinder with flat reversible key

Antiburglar



Systems



Duration



Finish



Cylinder classification - summary table on page 22

UNI EN 1303:2015 - ICIM 0039CS							
1	6	0	B	0	C	6	0

ANTI-PICKING:

Pass

ANTI-BUMPING:

Level 2

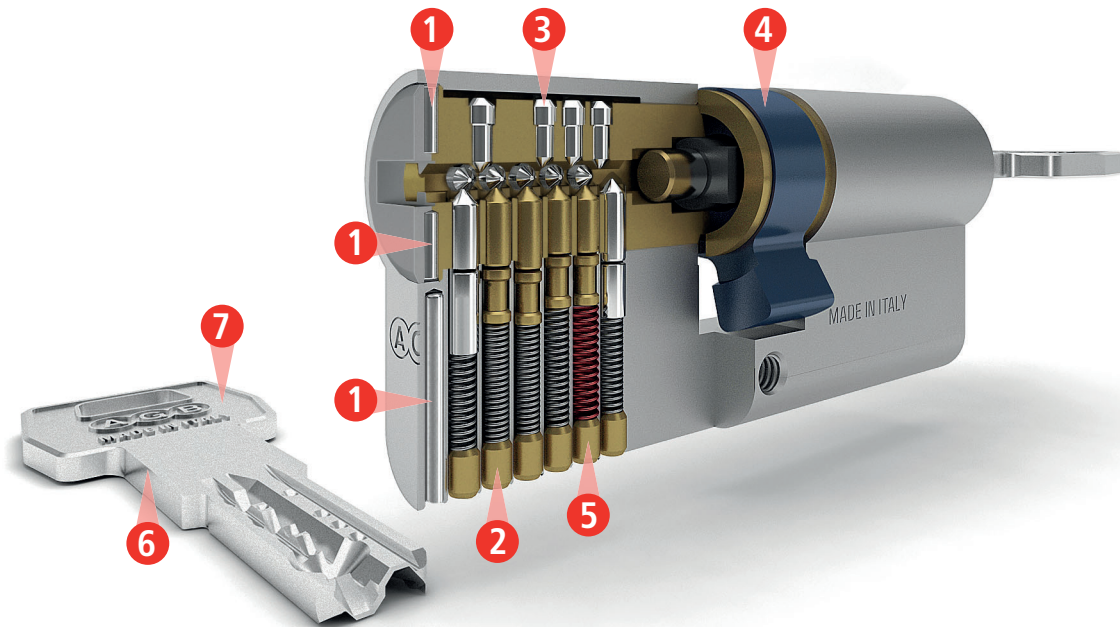

- 3 anti-drill pins in steel on each side. ①
- 6 active pins. ②
- 9 passive pins. ③
- Anti-pull cam in sintered steel. ④
- **High resistance to bumping**, certified according with ICIM 0039CS. ⑤
- 5 flat reversible keys with long neck that are resistant to torsion. ⑥
- Possibility to personalise the grip with many different coloured covers. ⑦
- Available with double function (2 keys inserted in the same time).
- Suitable for fire and smoke resistant doors.

600

Cylinder with profiled key

Antiburglar



Systems



Duration



Finish



Cylinder classification - summary table on page 22

UNI EN 1303:2015 - ICIM 0039CS							
1	6	0	B	0	C	3	0

ANTI-PICKING: Pass

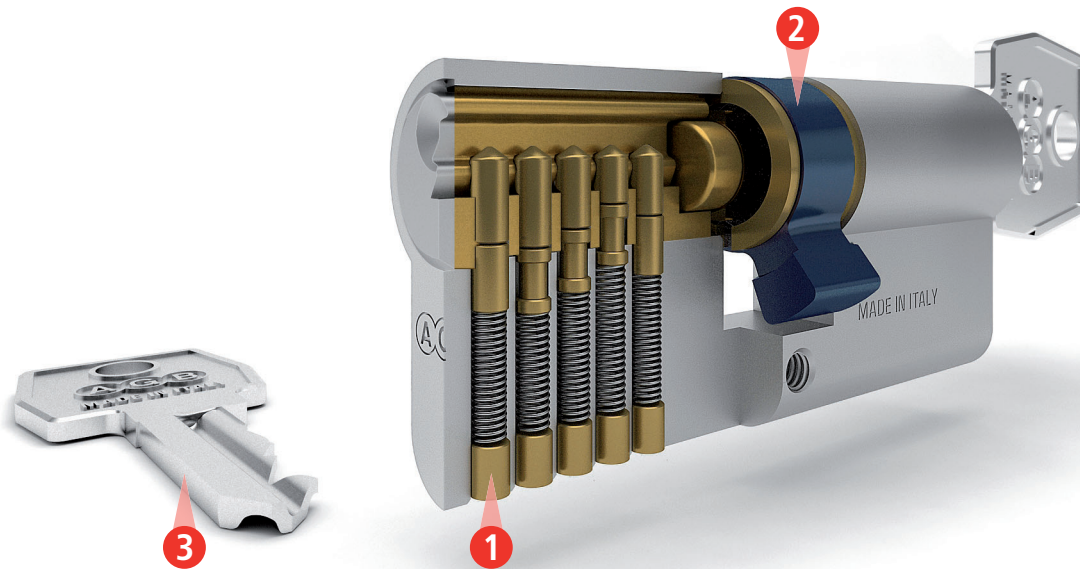

- 4 or 5 pins in brass for the coding. ①
- Anti-pull cam in sintered steel. ②
- 3 profiled keys. ③
- Wide possibility of existing coding.
- Suitable for fire and smoke resistant doors.

Tenax

Protective rim guard for cylinders



Round TENAX
(38 mm axis)



Oval TENAX
(20 mm axis)

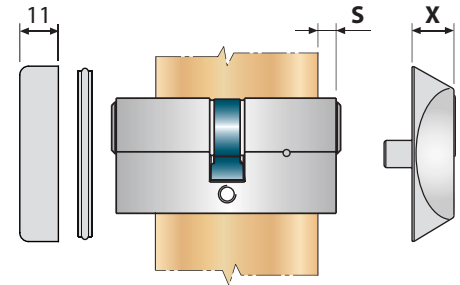
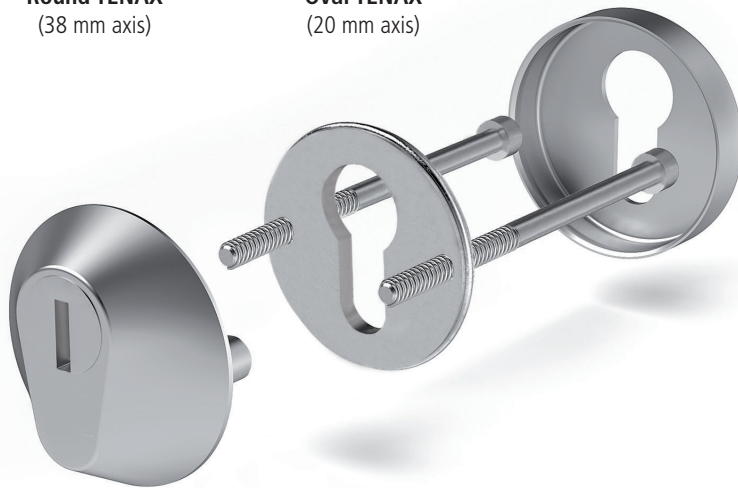

Choice of the Tenax thickness (X)
according with the cylinder protrusion (S).

GR	X mm	S mm
1	10	0÷4
2	12	0÷6
3	14	2÷8
4	16	4÷10
5	18	6÷12

- The oblique plane geometric shape makes it completely tool-proof.
- Unique body thanks to the surface in special steel.
- Anti-scratch surface and corrosion resistant in salt spray over 1,000 hours.

- Available in Round and Oval versions: 5 variations with thicknesses from 10 to 18 mm.
- Finish in satin chromium plated and glided PVD.
- Suitable for all the AGB cylinders with flat reversible key.

WIDE RANGE OF FINISHES



01. Plain

02. Bronze plated

06. Nickel plated

08. Satin brass

10. Enamelled

12. Antique brass plated

13. Satin nickel plated

16. Matt nickel plated

30. Chromium

32. Satin chromium plated

34. Matt chromium plated

72. Antique matt brass

84. Matt black

F9. Black titanium

CUSTOMISATION





































All the AGB cylinders can be personalised according to your needs.

*Tailor-made cylinders...
for all the doors!*



Up to 175 mm on each side, at 5 mm intervals

FULL CYLINDERS RANGE

CHARACTERISTICS	SCUDO DCK	SCUDO 9000	U-TECH PS	5000 PS	MOD. 600
 key-key					
 key - key double function					
 half cylinder - key					
 knob - key					
 18 mm tang - key					
 63 mm tang - key					
 knob - emergency cylinder					
 half cylinder - knob					

PASS KEY



The Pass key is available on request: the pass key is deactivated automatically when customer uses one of his keys for the first time. For availability, please make reference to the price list in force.

KA SYSTEM: THE PERFECT SOLUTION FOR PRIVATE HOUSES

KA

Key alike system

All cylinders have the same code and can therefore be opened with the same key.

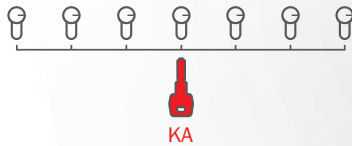

1 key
opens **all** the doors!



COMPLEX SYSTEMS

MK

Master key system

Each cylinder is opened with its own key, and no other cylinder of the system can be opened. All cylinders can be opened by management's master key MK.

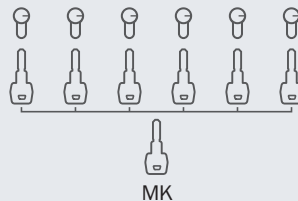

CC

Central cylinder system

Each cylinder is provided with its own key which cannot open any other cylinder of the system. All keys of the system can open the central lock cylinder.

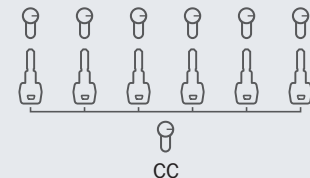

GMK SYSTEM: FOR OFFICES AND PUBLIC FACILITIES

GMK

General master key system

Each cylinder is opened with its own key, and no other cylinder of the system can be opened. The system is divided into subgroups of cylinders which can be opened only by their master key. All cylinders can be opened by director's master key GMK.

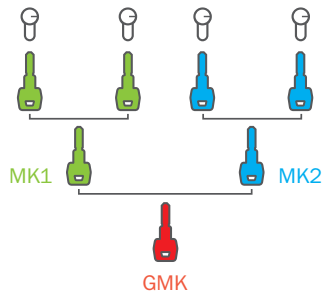

Control and accesses management



CCMK

Central cylinder system and master key

Each cylinder is opened with its own key, and no other cylinder of the system can be opened except the central cylinder (generally fitted on main entrance). All cylinders can be opened by management's master key MK.

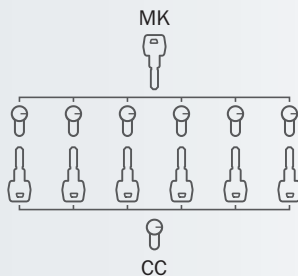

Comparative table of cylinders according with the regulations UNI EN 1303 and UNI EN 1627

CYLINDERS RANGE	UNI EN 1303:2015 - ICIM 0039CS - IMPORTANT INFORMATION					CERTIFICATE UNI EN 1303	UNI EN 1627:2011	
	digit 2	digit 4	digit 6	digit 7	digit 8		Resistance class	
	Durability	Fire resistance	Corrosion resistance	Key security	Attack resistance		a	b
							RC1-RC2-RC3	RC4-RC5-RC6
SCUDO DCK	6	B	C	6	D	●	●	●
SCUDO 9000	6	B	C	6	D	●	●	●
U-TECH PS	6	B	C	6	D	●	●	●
5000 PS	6	B	C	6	0	●		
Mod. 600	6	B	C	3	0	●		

Highest reachable result on the tests.

UNI EN 1303:2015 - ICIM 0039CS

ACCESSORIES FOR WINDOWS AND DOORS - CYLINDERS FOR LOCKS - REQUIREMENTS AND TEST METHODS

- Use** - Grade 1: for use by people with high knowledge of functioning and little chance of misuse.
- Durability** - Measured in 3 grades, from 4 to 6. The sequence indicates the number of opening/closing cycles where the cylinder is tested. To the sixth level, the cylinder reached 100,000 cycles.
- Door mass** - Grade 0: unique grade provided, no test is required.
- Fire resistance** - Grade 0: unsuitable for fire and smoke resistant doors. Grade A: suitable for smoke resistant doors. Grade B: suitable for fire and smoke resistant doors.
- Security** - Grade 0: unique grade provided, no test is required.
- Corrosion resistance** - Measured in 4 grades: 0-A-B-C. To reach the maximum level C, the cylinder is tested against the temperature leap from -25°C to +65°C and 96 hours in salt spray test according with the third level of the UNI EN 1670.
- Security of the key** - From 1 to 6, the 6 grades consider the number of the combinations and the security level. To reach the best result, the system has to offer 100,000 codings, impossibility to duplicate directly the key and reflect the standard requirements.
- Attack resistance** - 5 grades: 0-A-B-C-D- These 5 levels measure the cylinder ability to resist against the break-in attempts, as drilling, chisel attack, torsion, barrel extraction.
- Picking resistance**: Pass = Resistance to the manipulation with the picking method.
- Bumping resistance** - 4 levels: 1-2-3-X. At the X level, the cylinder resists against bumping and the test is not applicable. The other levels correspond to:
Level 1 = 5 minutes resistance and cut cylinders with all the same depth;
Level 2 = 10 minutes resistance and cut cylinders with all the same depth;
Level 3 = 15 minutes resistance and cut cylinders with different depth one from the other.

Example of cylinder classification

1	6	0	B	0	C	6	D
1	2	3	4	5	6	7	8
Use	Durability	Door mass	Fire resistance	Security	Corrosion resistance	Security of the key	Attack resistance

9 - ANTI-PICKING: Pass

10 - ANTI-BUMPING: Level 2

Note. The product certifications ICIM are available at the website www.agb.it

UNI EN 1627:2011

PEDESTRIAN DOORS - WINDOWS - FAÇADE - GRATINGS AND SWINGING CLOSINGS. ANTIBURGLAR RESISTANCE. REQUIREMENTS AND CLASSIFICATION.

- RC1 - RC2 - RC3**: minimum requirement for the UNI EN 1303 / **Security of the key** = 4; **Attack resistance** = Grade 1: UNI EN 1303:2015
- RC4 - RC5 - RC6**: minimum requirement for the UNI EN 1303 / **Security of the key** = 6; **Attack resistance** = Grade 2: UNI EN 1303:2015



Open, Close, Live

Alban Giacomo spa
Via A. De Gasperi 75,
36060 Romano d'Ezzelino (VI) Italy
+39 0424 832 832
www.agb.it - info@agb.it

MADE IN ITALY

A small graphic of the Italian flag, showing the vertical stripes of green, white, and red, positioned below the text.